

Quality
Made in
Germany



VOMM® GmbH

Pinzetten-Manufaktur
Prinzenstr.41
D-42697 Solingen

Bild-Preisliste Nr. 8.0

Telefon : 0212 329418
Fax : 0212 332631
E-mail: info@vomm.com
Internet: <http://www.vomm.com>

Die geschäftlichen Beziehungen der Vertragspartner unterliegen auch für alle zukünftig zwischen den Vertragspartnern geschlossenen Verträge den nachstehenden

Verkaufs-, Lieferungs- und Zahlungsbedingungen.

Diese Bedingungen gehen - auch ohne ausdrücklichen zusätzlichen Widerspruch - entgegenstehenden Geschäftsbedingungen des Kunden vor. Anderslautende Vereinbarungen und Nebenabsprachen bedürfen der schriftlichen Bestätigung.

P r e i s e: Die Listenpreise verstehen sich zuzüglich der gesetzlichen Mehrwertsteuer. Sie beinhalten die Kosten für eine einfache Papierverpackung, jedoch keine Kosten für Außenverpackungen oder Verpackungen nach besonderer Vorschrift. Diese werden gesondert in Rechnung gestellt. Porto und Versandkosten, sowie Kosten für eventuelle Transportversicherung sind in den Preisen nicht enthalten.

L i e f e r u n g: Der Versand der Ware geschieht auf Kosten und Gefahr des Kunden. Falls keine besonderen Versendungsformen vereinbart werden, wählt die Firma VOMM nach bestem Ermessen, jedoch ohne Verpflichtung den kostengünstigsten Versandweg. Die durch besondere Wünsche entstehende Mehrfracht geht zu Lasten des Kunden. Für Kleinaufträge unter 50 € steht es der Firma VOMM frei eine zusätzliche Bearbeitungsgebühr von 5,50 € zu erheben. Liefermöglichkeiten bleiben der Firma VOMM vorbehalten, die auch keine Verpflichtung zur Einhaltung der genannten Lieferzeiten übernimmt. Die Firma VOMM ist jedoch bemüht, die genannten Lieferzeiten einzuhalten.

B e a n s t a n d u n g e n: Offensichtliche Mängel der gelieferten Ware berücksichtigt die Verkäuferin nur, wenn sie längstens innerhalb von einer Woche angezeigt werden. Die Mitteilung hierüber muß nachweislich innerhalb dieser Frist abgesandt oder mündlich bzw. telefonisch zugeleitet worden sein.

Bei begründeten Mängelrügen ist die Firma VOMM nach ihrer Wahl zur Nachbesserung oder zur Ersatzlieferung berechtigt. Wandlung des Kaufvertrages oder Minderung des Kaufpreises können nicht verlangt werden. Schadensersatzansprüche aller Art, insbesondere auch solche für mittelbare Schäden, sind ausgeschlossen.

Bei einem Fehlschlagen der Nachbesserungen bzw. Ersatzlieferung besteht für den Kunden das Recht, den Vertrag rückgängig zu machen bzw. den Kaufpreis angemessen herabzusetzen.

Bei Mängel an fremdbezogenen Produkten ist die Firma VOMM berechtigt, unter Abtretung ihrer eigenen Gewährleistungsansprüche den Kunden zunächst zur Durchsetzung seiner Gewährleistungsansprüche an den Lieferanten der Firma VOMM zu verweisen.

Für Waren die ohne Zustimmung der Firma VOMM zurückgesandt werden, ist jede Haftung ausgeschlossen.

H ö h e r e G e w a l t: Ein Ereignis höherer Gewalt berechtigt die Verkäuferin, die Lieferung um die Dauer der Behinderung und eine angemessene Anlaufzeit hinauszuschieben, oder ganz oder wegen des noch nicht erfüllten Teils vom Verträge zurückzutreten. Als höhere Gewalt in diesem Sinne gelten auch: Krieg, Grenzsperr, Streiks sowohl im eigenen als auch in einem für die Rohstofflieferung in Betracht kommenden Unternehmen, Beförderungsschwierigkeiten durch fehlende Transportmöglichkeiten, Feuer, Verkehrshindernisse und -störungen. Einschränkung oder Einstellung des Betriebes oder Zufuhr von Rohstoffen, kurz alle Umstände, welche die Herstellung der Ware beschränken oder unmöglich machen.

E i g e n t u m s v o r b e h a l t: Die Lieferung der Ware erfolgt unter Eigentumsvorbehalt gemäß § 455 BGB mit der Maßgabe, daß die Ware bis zur vollständigen Bezahlung sämtlicher, auch künftiger Forderungen aus der Geschäftsverbindung mit dem Kunden - also bis zum völligen Saldenausgleich oder bis zur vollen Einlösung in Zahlung gegebener Wechsel oder Scheck - Eigentum der Firma VOMM bleibt.

Der Kunde ist berechtigt, die Ware im ordnungsgemäßen Geschäftsgang zu veräußern. Er tritt aber schon jetzt alle ihm aus der Weiterveräußerung der Ware gegen seine Abnehmer zustehenden Forderungen an die Verkäuferin in Höhe der dann noch dieser gegenüber bestehenden Kaufpreisschuld ab. Auf Verlangen der Verkäuferin ist der Kunde verpflichtet, die Abtretung seinem Abnehmer bekanntzugeben und der Verkäuferin die zur Geltendmachung ihrer Rechte gegen den Abnehmer erforderlichen Auskünfte zu geben und Unterlagen auszuhändigen.

Für den Fall, daß das Eigentumsrecht der Firma VOMM durch Maßnahmen Dritter (Pfändung) oder durch besondere Ereignisse (Konkurs des Kunden etc.) beeinträchtigt werden könnte, ist der Kunde verpflichtet, der Firma VOMM umgehend Mitteilung zu machen und dritte Personen auf das Eigentumsrecht der Verkäuferin hinzuweisen.

Wird die Ware von dritter Seite gepfändet oder das Eigentum der Verkäuferin durch andere Maßnahmen gefährdet, so hat sie der Kunde hiervon unverzüglich unter Beifügung des Pfändungsprotokolls und der eidesstattlichen Erklärung des Inhalts, daß es sich bei dem von dem Dritten in Anspruch genommenen Gegenstand um das Eigentum der Verkäuferin handelt, zu benachrichtigen.

Bei Verarbeitung der Vorbehaltsware wird der Eigentumserwerb nach § 950 BGB ausgeschlossen. Der Eigentumsvorbehalt erstreckt sich dadurch anteilmäßig auf das durch die Verarbeitung neu entstandene Produkt.

Z a h l u n g s a r t: Rechnungen werden frühestens auf den Tag der Lieferung ausgestellt. Der Kaufpreis ist mit der Rechnungserteilung fällig. Die Rechnungsbeträge sind zahlbar innerhalb von acht Tagen nach Rechnungsdatum abzüglich 2% Skonto, bzw. innerhalb von 30 Tagen netto Kasse, wobei der Zahlungseingang bei der Firma VOMM bzw. die Gutschrift auf dem Konto der Firma VOMM maßgeblich ist. Die Aufrechnung oder die Geltendmachung eines Zurückbehaltungsrechtes des Kunden ist ausgeschlossen, es sei denn, es handelt sich um eine unbestrittene oder rechtskräftig festgestellte Forderung des Kunden.

Bei Zielüberschreitung werden angemessene, jedenfalls aber 2% über dem jeweils geltenden Diskontsatz der Deutschen Bundesbank liegende Verzugszinsen berechnet.

Auf Porto- und Verpackungskosten wird kein Skonto gewährt.

S o n s t i g e s: Geringfügige Änderungen, welche dem Fortschritt dienen, behält sich die Firma VOMM vor. Abweichungen in der Ausführung von Werkzeugen, welche die Funktion nicht beeinträchtigen, beruhen auf Handarbeit und gelten als unvermeidbar.

E r f ü l l u n g s o r t u n d G e r i c h t s s t a n d: Erfüllungsort für Lieferungen und Leistungen für alle sich aus dem Geschäft ergebenden beiderseitigen Rechte und Pflichten ist Leichlingen. Gerichtsstand ist Solingen. Dies gilt insbesondere auch für das gerichtliche Mahnverfahren.

T e i l n i c h t i g k e i t: Sollte ein Punkt dieser Verkaufs-, Lieferungs- und Zahlungsbedingungen nichtig sein, so behalten alle übrigen Punkte ihre volle Rechtskraft. Ein nichtiger Punkt ist durch den rechtlich wirksamen zu ersetzen, der dem gewollten wirtschaftlich am nächsten kommt.

A n z u w e n d e n d e s R e c h t: Soweit nichts anderes vereinbart ist, gelten unabdingbar die gesetzlichen Bestimmungen der Bundesrepublik Deutschland.

Material-Code, z. B. bei Modell 5a:

5a	Stahl vernickelt bzw. blank eingeölt <i>Carbon Steel, nickel-plated or oiled</i>
5a S	Rostfreier Chromstahl, gehärtet <i>Stainless Chrome-Steel, hardened</i>
5a SA	Chrom/Nickel-Edelstahl, Rostfrei, antimagnetisch und bedingt säurebeständig <i>Chrome/Nickel-Steel, Stainless, anti-magnetic and anti-acid</i>
5a SA-T	dto., jedoch ganz Teflon beschichtet <i>same, but tips coated with Teflon (PTFE)</i>
5a SA-PVD	dto., jedoch komplett mit PVD-Beschichtung <i>same, but completely PVD-coated</i>
5a SA-ESD	<i>Schutz vor elektronischer Überbelastung bei Bauteilen, elektrostatisch hoch-ohmig ableitend, mit TÜV-Zertifikat ESD.</i> <i>Protection against electronic overload as far as chip components are concerned, electrostatic OHM-conductive, with TÜV-Certificate ESD.</i>
R5a SA	dto, jedoch als selbstklemmende, durchgesteckte Kreuzpinzette <i>same, but manufactured as reversible Tweezer (box-joint)</i>
5a TA	Titan <i>Titanium</i>
5a NS	Neusilber <i>German Silver</i>
5a CA	Spezialstahl, Rostfrei, un-magnetisch und super-säurebeständig <i>Special alloy, stainless, non-magnetic and super-acid-resistant</i>
5a ALU	Aluminium <i>Aluminium</i>
5a M	Messing <i>Brass</i>

Nachdruck, vollständig oder auch ausdrucksweise, sowie Weitergabe oder Vervielfältigung ist ohne die ausdrückliche schriftliche Genehmigung untersagt!

Diese Bild-Preisliste annulliert alle vorherigen Preislisten.

Alle Preise zuzüglich der gesetzlichen Mehrwertsteuer

Das Eigentumsrecht an der Bild-Preisliste bleibt vorbehalten.

Alle Zeichnungen sind so naturgetreu wie möglich, aber unverbindlich.

Modelländerungen vorbehalten.



INHALTSVERZEICHNIS / TABLE OF CONTENTS

Seiten	
5	Diverse gängige Pinzetten
6	Diverse gut laufende Pinzetten
7	Diverse sehr gefragte Pinzetten
8	Universalpinzetten, ESD-beschichtete Pinzetten
9	Universalpinzetten, ESD-beschichtete Pinzetten PTFE-(Teflon) beschichtete Pinzetten
10	Universalpinzetten, ESD-beschichtete Pinzetten
11	Universalpinzetten, ESD-beschichtete Pinzetten
12	Biegepinzetten, ESD-beschichtete Pinzetten
13	Spezialpinzetten für SMD-Bauteile, ESD-beschichtete Spezialpinzetten
14	Waferpinzetten, PTFE-(Teflon) beschichtete Waferpinzetten
15	Waferpinzetten, PTFE-(Teflon) beschichtete Waferpinzetten
16	Waferpinzetten, PTFE-(Teflon) beschichtete Waferpinzetten
17	Spitze Pinzetten
18	Stumpfe Pinzetten
19	Spitze Montagepinzetten
20, 46	Spitze, schutzisolierte, PVC-beschichtete Pinzetten
20	Auswechselbare, auf spitze + breite Pinzetten
21, 22, 23	Steckerzieher-Pinzetten 120 mm lang
24	Schwere Steckerzieher-Pinzetten, 145 mm lang
25, 26, 27	Diverse Kreuzpinzetten
27	Keramikpinzetten und Trimmer
28	Manikürpinzetten
28	Skalpellgriffe und diverse Klingen
29	Lackabkratzer, Chipklemmpinzetten, Feststellpinzetten
30	Juwelierpinzetten, Aufnahme Kreuzpinzetten
31	Schneide-, Wäge-, Pinzetten zur Aufnahme von Minimelves
32, 55	Mundspiegel, Kehlkopfspiegel, Teleskopgriffe
33, 34, 37	Haken, Sonden, Excavatoren
35, 34	Mikrospatel Mikrolöffel, Löthaken, Pulverspatel
38, 39, 40, 41	Nichtmetallische (Kunststoffpinzetten, Klemmen)
42, 43, 44, 45	Nichtmetallische (Kunststoffpinzetten), Nadelhalter, Klemmen, Zangen
46	Schutzisolierte Pinzetten
47	Schneidepinzetten, Feilchenfeldpinzetten
48	Klemmgreifer, Krallengreifer
49, 50	Vakuumpinzetten
51	Saugnadeln, Sauger
52	Vakuum-Saugschlauch
53	Fingersauggriffel, Handsauggriffel, Spezialsaugvorrichtung
54	Tool-Servant / Pinzettenhalter
55	Griffe, Teleskopgriffe, Spiegel

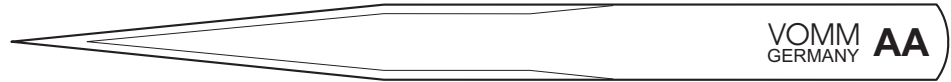

AA 9184 7,42 €
AA S 9284 8,62 €
AA SA 9384 9,12 €
AA M 9484 11,80 €

Universalpinzette, sehr populär
Universal Tweezer, very popular

130 mm



No Nickel-Allergy!

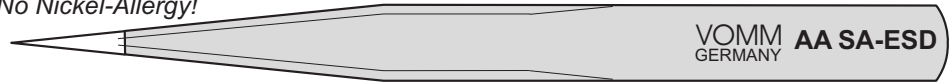

AA SA-ESD 3616 9,06 €

Wie AA SA, jedoch ESD-beschichtet
Same as AA SA, but ESD-coated



130 mm

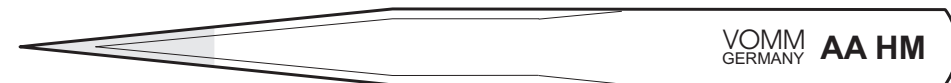

AA HM 8400 49,62 €

Wie AA S, jedoch mit Hartmetall bestückt
Same as AA S, but tips fitted with Hardmetal

128 mm

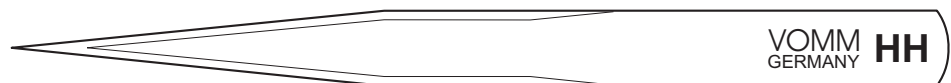

HH 8184 8,28 €

Universalpinzette, sehr populär *Universal Tweezer, very popular*

120 mm



Ac 9000 11,66 €

stabil
heavy

110 mm

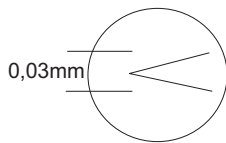

BB 9390 8,04 €

Leichte Hohlpinzette, Spitze mit Ansatz
Light-weight and hollow, structured point

115 mm



F SA 9382 12,64 €

Flache Spitzen wie 2a, jedoch eckig
Flat tips as 2a, but square

120 mm

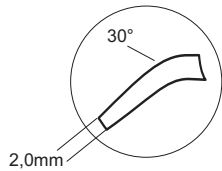

Fb SA 9640 15,00 €

Flach-eckige Spitzen wie F, jedoch gebogen
Flat square tips as F, but bent

117 mm



GG SA 9388 16,82 €

Amerikanische Form
American Style

130 mm



No Nickel-Allergy!



GG SA-ESD 3617 11,90 €

Wie GG SA, jedoch ESD-beschichtet
Same as GG SA, but ESD-coated

130 mm



PSF SA 9389 11,40 €

Wie AA, jedoch eckig-breite Spitze mit Zahnung
Same as AA, but fine square tips with serration

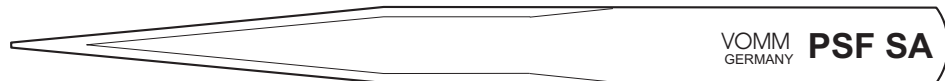

PSF SA 9385 9,94 €

Wie AA, jedoch eckig-breite Spitze ohne Zahnung
Same as AA, but fine square tips without serration

130 mm



RR 9015 12,30 €

Breit und stark
Broad and strong

145 mm



No Nickel-Allergy!

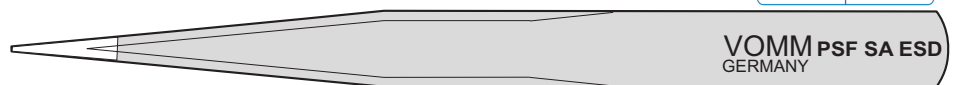

PSF SA-ESD 3615 11,16 €
 3633 11,78 €

Wie PSF SA, jedoch ESD-beschichtet
Same as PSF SA, but ESD-coated
 Wie PSF SA- ESD, jedoch mit Zahnung
Same as PSF SA - ESD, but serrated

130 mm





SS SA 9387 **12,46 €** Schlank und schwach
Narrow, low resilience 135 mm

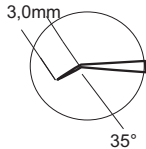

SSbb SA 6971 **14,50 €** Wie SS, jedoch Spitze kurz gebogen
Same as SS, but tips short bent 133 mm



Schlank und schwach
Narrow, low resilience

No Nickel-Allergy!



SS SA-ESD 3619 **13,22 €** Wie SS SA, jedoch ESD-beschichtet *Same as SS SA, but ESD-coated*

SSbb SA-ESD 3613 **14,64 €** Wie SSbb SA, jedoch ESD-beschichtet *Same as SSbb SA, but ESD-coated*

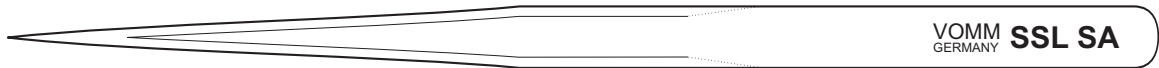

SSL SA 9487 **15,86 €** Länger und stärker als SS
Longer and stronger than SS 160 mm

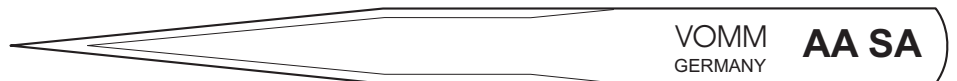

AA SA 9386 **9,84 €** Wie AA, jedoch mit Zahnung
Same as AA, but with serration 130 mm



VOMM GERMANY 00 SA

00 SA 8700 14,16 €

Dick, mittelfeine Spitzen *Thick, semi-pointed tips*

120 mm

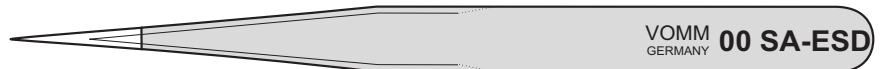

VOMM GERMANY 00 SA-ESD

No Nickel-Allergy!



00 SA-ESD 3629 15,56 €

Wie 00 SA, jedoch ESD-beschichtet *Same as 00 SA, but ESD-coated*

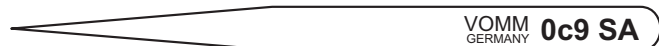

VOMM GERMANY 0c9 SA

0c9 SA 8710 11,66 €

schmal, glatt *narrow, smooth*

90 mm



VOMM GERMANY 1 SA

1 SA 8980 11,80 €

Universell einsetzbar *All Purpose Tweezer*

120 mm

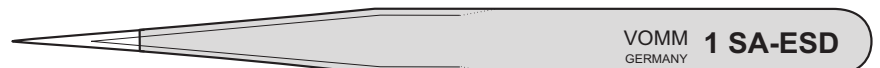

VOMM GERMANY 1 SA-ESD

No Nickel-Allergy!



1 SA-ESD 3628 11,92 €

Wie 1 SA, jedoch ESD-beschichtet *Same as 1 SA, but ESD-coated*

120 mm



VOMM GERMANY 2 SA

2 SA 9381 12,48 €

Mittelfeine Spitzen *Semi-pointed tips*

120 mm



No Nickel-Allergy!

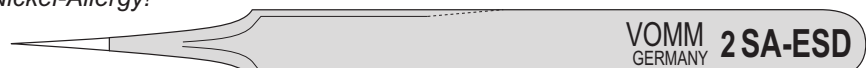

VOMM GERMANY 2 SA-ESD

120 mm

Mittelfeine Spitzen *Medium-fine tips*



2 SA-ESD 3609 10,78 €

Wie 2 SA, jedoch ESD-beschichtet *Same as 2 SA, but ESD-coated*

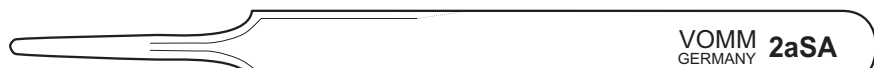

VOMM GERMANY 2aSA

2a SA 9378 12,48 €

Flach-runde Spitzen *Flat-round tips*

120 mm



VOMM **2a SA-T**
GERMANY anti-allergy

2a SA-T 9478 **19,18 €**

Wie 2a SA, jedoch mit PTFE beschichtet
Same as 2a SA, but coated with PTFE

120 mm



No Nickel-Allergy!



VOMM **2a SA-ESD**
GERMANY

120 mm

2a SA-ESD 3611 **11,34 €**

Wie 2a SA, jedoch ESD-beschichtet
Same as 2a SA, but ESD-coated

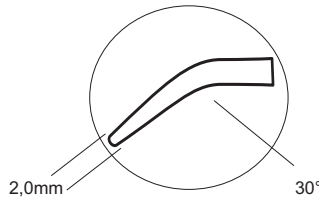

VOMM **2ab SA**
GERMANY

2ab SA 9368 **15,54 €**

Spitze wie 2a, jedoch winklig gebogen
Same tips as 2a, bent

117 mm



VOMM **3 SA**
GERMANY

3 SA 9383 **12,64 €**

Spitz

3M 9483 **16,52 €**

Pointed

120 mm



No Nickel-Allergy!



VOMM **3 SA-ESD**
GERMANY

120 mm

3 SA-ESD 3608 **11,52 €**

Wie 3 SA, jedoch ESD-beschichtet
Same as 3 SA, but ESD-coated

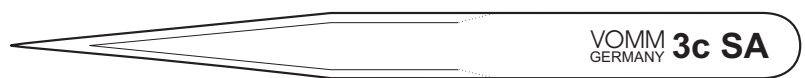

VOMM **3c SA**
GERMANY

3c S 9683 **12,80 €**

Rostfrei
Stainless

110 mm

3c SA 9783 **12,64 €**

Wie 3, jedoch kürzer
Same as 3, but shorter

110 mm



No Nickel-Allergy!

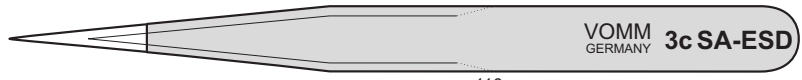

VOMM GERMANY 3c SA-ESD

110 mm

Wie 3c SA, jedoch ESD-beschichtet

Same as 3c SA, but ESD-coated



3c SA-ESD 3610 11,52 €

4 S 9679 13,26 € Rostfreier Chromstahl gehärtet Stainless Chrome-Steel hardened 110 mm

4 SA 9779 12,64 €

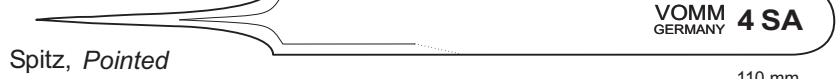
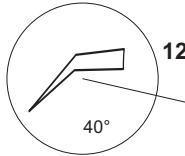

VOMM GERMANY 4 SA

110 mm

Spitz, Pointed



VOMM GERMANY 4b SA

Spitz, gebogen Pointed, bent

4b S 9280 15,04 € Rostfreier Chromstahl gehärtet Stainless Chrome-Steel hardened 110 mm

4b SA 9380 13,34 € Chrom / Nickel - Edelstahl Chrome / Nickel - Steel hardened 110 mm



No Nickel-Allergy!



VOMM GERMANY 4 SA-ESD

110 mm

Wie 4 SA, jedoch ESD-beschichtet

Same as 4 SA, but ESD-coated



4 SA-ESD 3618 11,90 €

MF 5 SA 9379.1 17,06 € Chrom / Nickel - Edelstahl 110 mm

Very pointed Sehr spitz



VOMM GERMANY 5 SA

5 S 9279 12,58 € Rostfreier Chromstahl gehärtet Stainless Chrome-Steel hardened 110 mm

5 SA 9379 12,64 € Chrom / Nickel - Edelstahl Chrome / Nickel - Steel hardened 110 mm



No Nickel-Allergy!



VOMM GERMANY 5 SA-ESD

110 mm

Wie 5 SA, jedoch ESD-beschichtet

Same as 5 SA, but ESD-coated



5 SA-ESD 3604 11,90 €

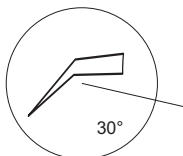

VOMM GERMANY 5bb SA

107 mm

5bb SA 6972 14,16 € Sehr spitz, kurz gebogene Spitze, 3mm lang Very pointed, short bent tips, 3mm long

5bb SA-ESD 3627 14,28 € Wie 5bb SA, jedoch ESD-beschichtet Same as 5bb SA, but ESD-coated

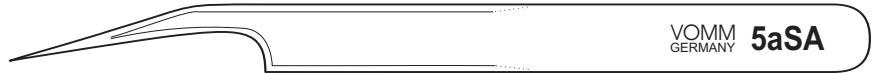

5a SA

9377 **13,16 €**

Spitz
Pointed

120 mm

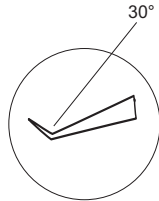

5abb SA

6970 **15,00 €**

Feine, kurz gebogene Spitze

Fine, short bent tips

117 mm

5abb SA-ESD

3625 **15,86 €**

Wie 5abb SA, jedoch ESD-beschichtet

Same as 5abb SA, but ESD-coated

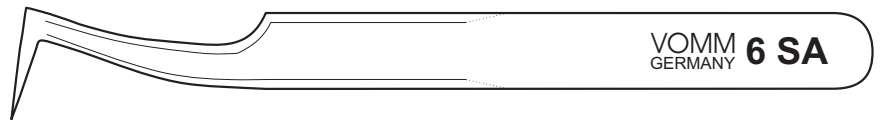

6 SA

6987 **14,84 €**

Feine Hakenspitze
Fine, hooked tips

120 mm

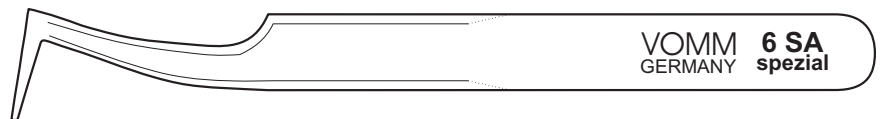
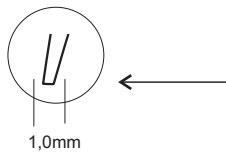

6 spez. SA

6986 **14,98 €**

Wie 6 SA, jedoch eckige Spitze
Same as 6 SA, but square tips

115 mm

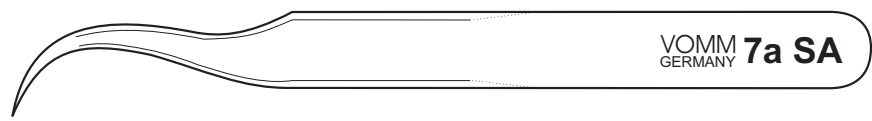
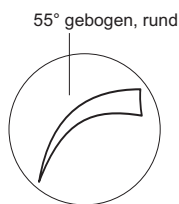

7a SA

9376 **15,18 €**

Feine Sichelspitze *Fine lunate tips*

120 mm

7a SA-T

9391 **21,94 €**

Wie 7a SA, jedoch Teflon-beschichtet

Same as 7a SA, but Teflon-coated

120 mm



No Nickel-Allergy!

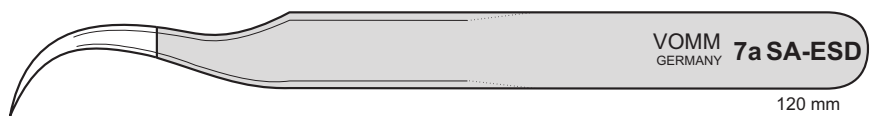

7a SA-ESD

3605 **14,90 €**

Wie 7a SA, jedoch ESD-beschichtet
Same as 7a SA, but ESD-coated

120 mm



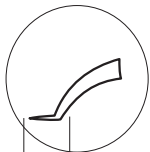

3mm Winklig versetzt 30°



Feine Sichelform mit kurzer gerader Spitze, 3mm lang

7abb SA 6950 **17,68 €**

Fine lunate shape with short straight tips, 3mm long

120 mm

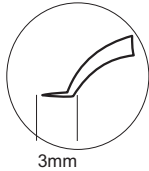

3mm Winklig versetzt 30°

No Nickel-Allergy!



7abb SA-ESD 3612 **17,84 €**

Wie 7abb SA, jedoch ESD-beschichtet
Same as 7abb SA, but ESD-coated



120 mm



120 mm

7 SA 9375 **13,66 €**

mit kurzer gerader Spitze

shape with short straight tips

7 SA-ESD 3630 **14,64 €**

Wie 7 SA, jedoch ESD-beschichtet

Same as 7 SA, but ESD-coated

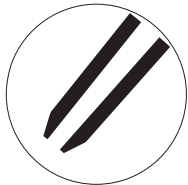

10 mm



8 SA 3800 **13,16 €**

Biegepinzette
Forming Tweezer

120 mm

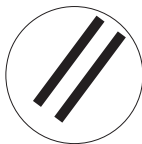

8b 3802 **11,44 €**

Biegepinzette
Forming Tweezer

100 mm

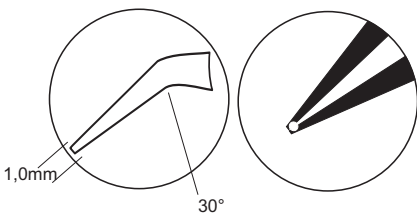

1,0mm

30°

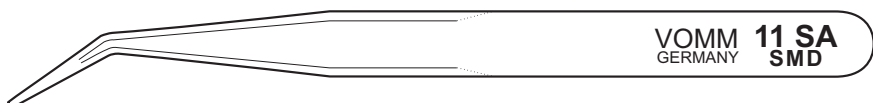

11 SA-SMD 6611 **15,54 €**

Passend für Mini-MELF, Einfräsung $\varnothing 0,5\text{mm}$
For Mini-MELF, milled slot, $\varnothing 0,5\text{mm}$

117 mm

8 SA-SMD 6615 **15,18 €**



Glatt

Smooth

VOMM GERMANY **8 SA SMD**

120 mm

8a SA-SMD 6617 **17,20 €**

Mit Einfräsung, $\varnothing 0,5$ mm Milled slot, $\varnothing 0,5$ mm

VOMM GERMANY **8a SA SMD**

120 mm

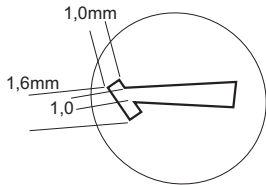

8b SA-SMD 6616 **15,70 €**

Wie 8 SA-SMD, jedoch gebogen

Same as 8 SA-SMD, but bent

8b SA SMD-ESD 3624 **15,16 €**

Wie 8b SA-SMD, jedoch ESD-beschichtet

Same as 8b SA-SMD, but ESD-coated

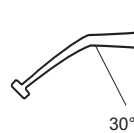

VOMM GERMANY **8b SA SMD**

120 mm

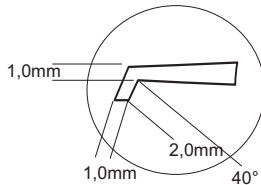

12 SA-SMD 6612 **14,84 €**

Spezialpinzette, u.a. für SMD-Bauelemente

Special Tweezer, e.g. for SMT-Chips



VOMM GERMANY **12 SA SMD**

120 mm

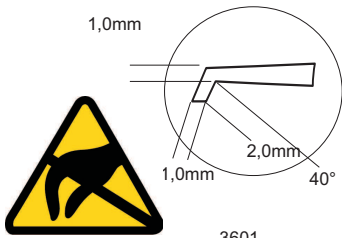

12 SA-SMD ESD 3601 **14,52 €**

No Nickel-Allergy!

Wie 12 SMD, jedoch ESD-beschichtet

Same as 12 SMD, but ESD-coated

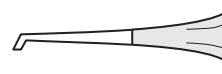

VOMM GERMANY **12 SA SMD-ESD**

120 mm

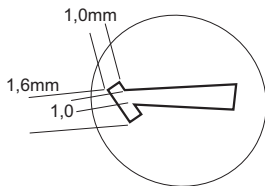

13 SA-SMD 6613 **14,84 €**

Spezialpinzette, u.a. für SMD-Bauelemente

Special Tweezer, e.g. for SMT-Chips



VOMM GERMANY **13 SA SMD**

120 mm

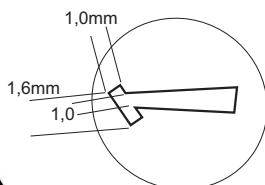

13 SA-SMD ESD 3602 **14,52 €**

No Nickel-Allergy!

Wie 13 SMD, jedoch ESD-beschichtet

Same as 13 SMD, but ESD-coated

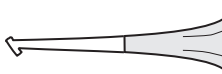

VOMM GERMANY **13 SA SMD-ESD**

120 mm





14 S 7977 **14,84 €** Spitzen 4 mm breit
Tips 4 mm wide 115 mm



15a 9501 **41,72 €** Schneidepinzette
Cutting-Tweezer 115 mm



72a SA 7299 **16,68 €** Waferpinzette, 3 mm breite Spitze
Wafer Tweezer, 3 mm wide tips 115 mm



37 SA 3729 **22,88 €** Waferpinzette mit 2 Anschlagwinkel und schmalem Oberteil
Wafer Tweezer with 2 stop pins and narrow upper-shank 120 mm

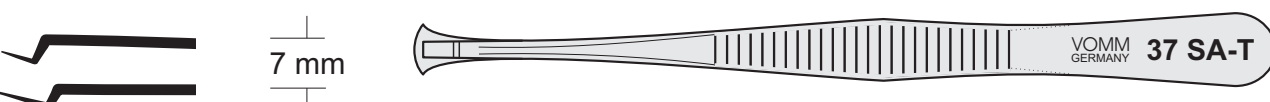

NEU! NEW!
37 SA-T 3731 **29,60 €** Waferpinzette mit 2 Anschlagwinkel und schmalem Oberteil, PTFE-beschichtet
Wafer Tweezer with 2 stop pins and narrow upper-shank, coted with PTFE 120 mm

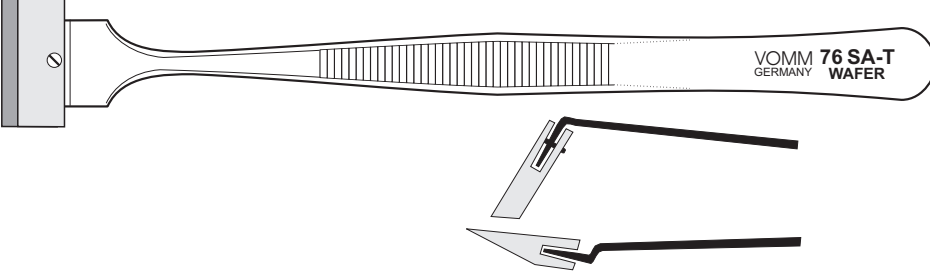

76 SA-T 6070 **48,62 €** Waferpinzette, 31 mm breit, mit Teflon-Paddel
Wafer Tweezer, 31 mm wide, with PTFE Pad 125 mm

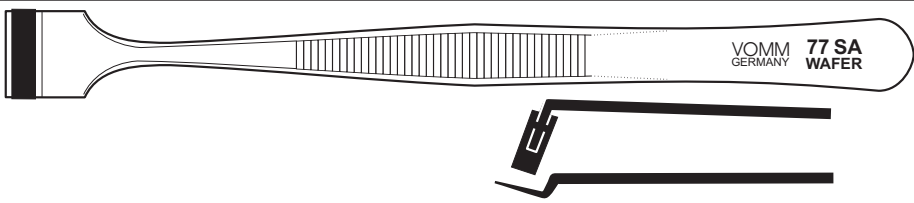

77 SA-T 3779 **27,58 €** Waferpinzette, 12 mm breit, mit Teflon-Paddel
Wafer Tweezer, 12 mm wide, with PTFE Pad 125 mm

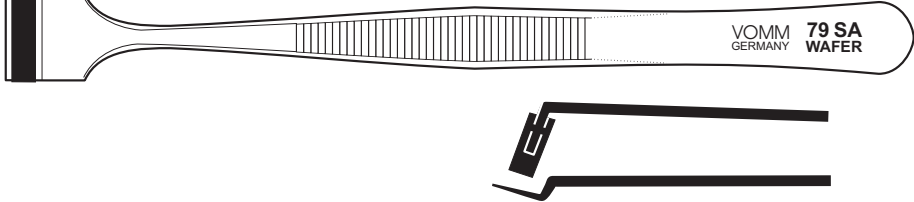

NEU! NEW!
79 SA-T 3780 **34,22 €** Waferpinzette, 20 mm breit, mit Teflon-Paddel
Wafer Tweezer, 20 mm wide, with PTFE Pad 125 mm

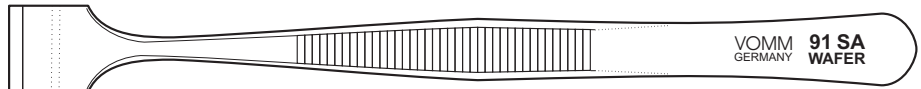

91 SA 7600 **16,36 €**

Waferpinzette, 12 mm breit
Wafer Tweezer, 12 mm wide

125 mm

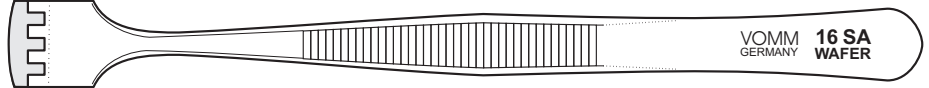

16 SA 4149 **16,84 €**

Wafer Pinzette, 12 mm breit
Wafer Tweezer, 12 mm wide

16 SA-T 4150 **23,38 €**

Wie 16 SA, jedoch ganz Teflon beschichtet
Same as 16 SA, but coated with Teflon

125 mm

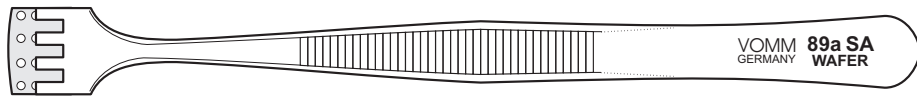

89 SA 3948 **17,36 €**

Wafer Pinzette, 9 mm breit *Wafer Tweezer, 9 mm wide*

125 mm

89a SA 3949 **18,48 €**

Wafer Pinzette, 12 mm breit *Wafer Tweezer, 12 mm wide*

125 mm

89 SA-T 3951 **24,72 €**

Wie 89 SA, jedoch ganz Teflon beschichtet

125 mm

89a SA-T 3950 **24,08 €**

Same as 89a SA, but coated with Teflon

125 mm

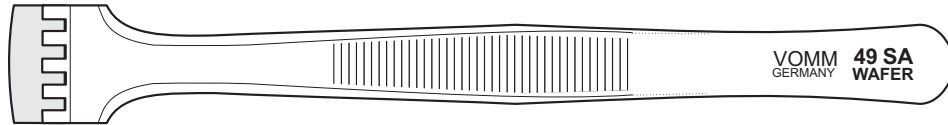

49 SA 4159 **17,68 €**

Waferpinzette, 16 mm breit
Wafer Tweezer, 16 mm wide

125 mm

49 SA-T 4160 **24,16 €**

Wie 49 SA, jedoch ganz Teflon beschichtet
Same as 49 SA, but coated with Teflon

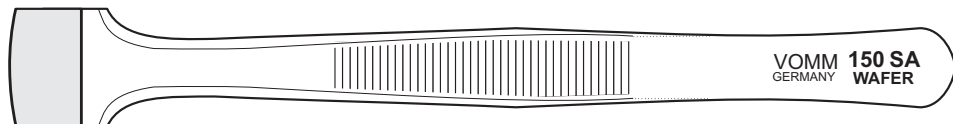

150 SA 5039 **27,74 €**

Waferpinzette, 16 mm breit
Wafer Tweezer, 16 mm wide

125 mm

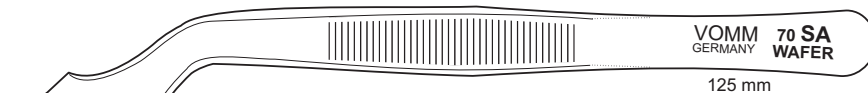

70 SA 6069 **31,74 €**

Waferpinzette, 20 mm breit / *Wafer Tweezer, 20 mm wide*

125 mm

60 SA 6073 **25,72 €**

Wie 70 SA, jedoch gerade / *Same as 70 SA, but straight*

60 SA-T 6074 **34,80 €**

Wie 60 SA, jedoch ganz Teflon beschichtet *Same as 60 SA, but coated with Teflon*

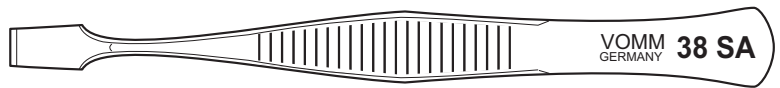

38 SA 9585 **11,96 €**

Flach-breite Spitze, gerade *Flat, broad Tips*

105 mm

38a SA 9587 **12,98 €**

Wie 38 SA, jedoch gebogene Spitze *Same as 38 SA, but bent tips*

103 mm

38a 9589 **1,20 €**

Vernickelt, Preisgünstig *Nickel-plated, Low-Cost*

103 mm

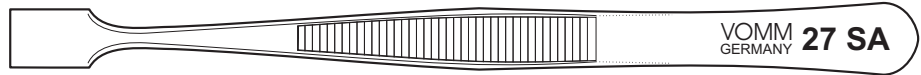
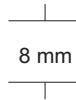

27 SA

9600 **12,48 €**

Flach und eckig

Flat and square

27a SA

125 mm

27a SA

9620 **16,52 €**

dto, jedoch gebogen

Same, but bent



123 mm

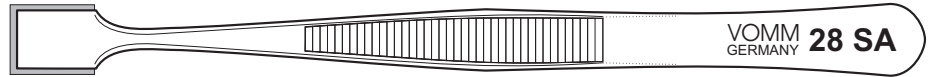
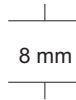

28 SA

9610 **13,16 €**

Wie 27 SA, mit Filz

Same as 27, with felt

28a SA

125 mm

28a SA

9630 **17,88 €**

Dto, jedoch gebogen

Same, but bent

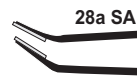

123 mm

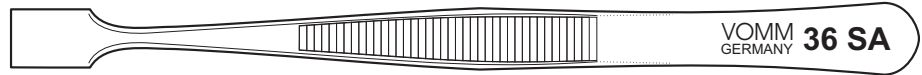
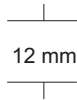

36 SA

7715 **12,64 €**

Flach und eckig

Flat and square

36a SA

125 mm

36a SA

7716 **13,66 €**

dto, jedoch gebogen

Same, but bent



123 mm

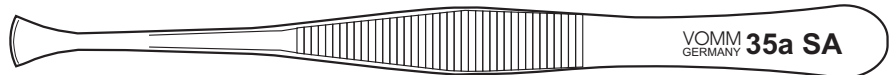
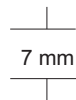

35a SA

7982 **12,82 €**

Halbrunde, dünne Spitzen

Half-round and thin tips

120 mm

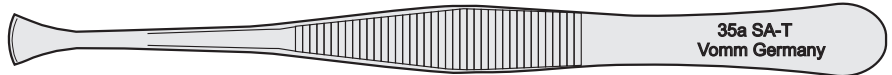

35a SA-T

7983 **19,56 €**

Wie 35a SA, jedoch ganz mit PTFE beschichtet

Same as 35a SA, but completely coated with PTFE

120 mm

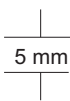

39 SA

9584 **12,48 €**

Flach und eckig

Flat and square

125 mm

39a SA

9588 **13,66 €**

dto., jedoch gebogen

Same, but bent tips

123 mm

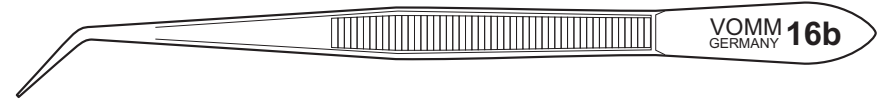
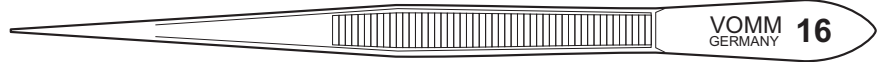
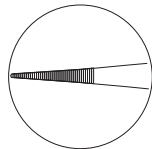

16	2010	6,60 €	Vernickelt, Spitze mit feiner Zahnung		120 mm
16b	2011	7,58 €	Nickel-plated, fine-serrated tips		120 mm

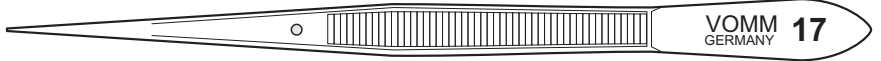
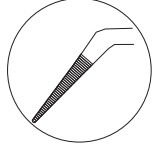
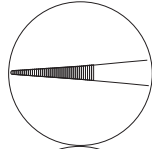

Mit Führungsstift with guide-pin

17	2012	8,28 €	wie Mod. 16	as Mod. 16	120 mm
17b	2013	9,78 €	wie Mod. 16b	as Mod. 16b	120 mm

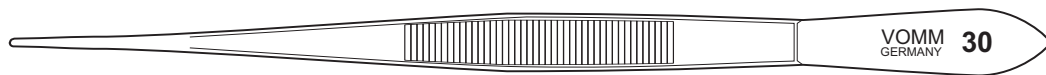
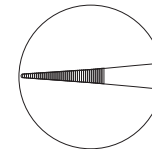

30	5010	8,28 €	vernickelt, feine Zahnung	nickel-plated, fine serrated	145 mm
32	5110	10,46 €	vernickelt, feine Zahnung	nickel-plated, fine serrated	165 mm
34 SA	5210	10,80 €	18/10, feine Zahnung	stainless, antimagnetic, fine serrated	120 mm

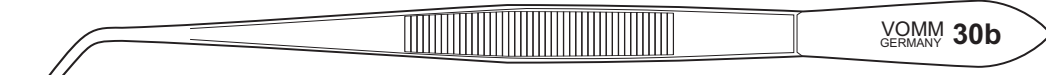
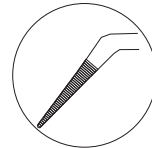

30b	5011	8,96 €	vernickelt, feine Zahnung	nickel-plated, fine serrated	145 mm
32b	5111	11,80 €	vernickelt, feine Zahnung	nickel-plated, fine serrated	165 mm
34b SA	5211	11,44 €	18/10, feine Zahnung	stainless, antimagnetic, fine serrated	120 mm

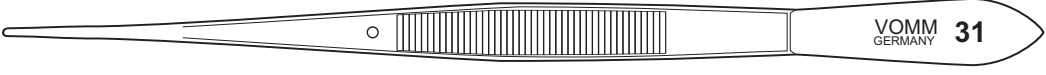
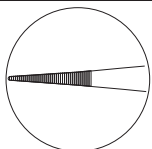

Mit Führungsstift with guide-pin

31	5012	9,62 €	vernickelt, feine Zahnung	nickel-plated, fine serrated	145 mm
33	5112	12,48 €	vernickelt, feine Zahnung	nickel-plated, fine serrated	165 mm
35 SA	5212	12,12 €	18/10, feine Zahnung	stainless, antimagnetic, fine serrated	120 mm

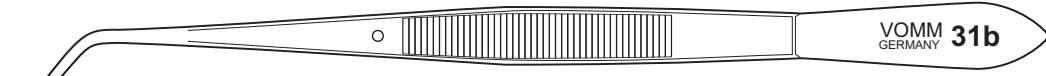
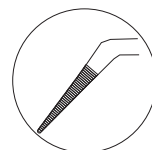

Mit Führungsstift with guide-pin

31b	5013	10,30 €	Vernickelt, feine Zahnung	nickel-plated, fine serrated	145 mm
33b	5113	13,16 €	vernickelt, feine Zahnung	nickel-plated, fine serrated	165 mm
35b SA	5213	12,64 €	18/10, feine Zahnung	stainless, antimagnetic, fine serrated	120 mm

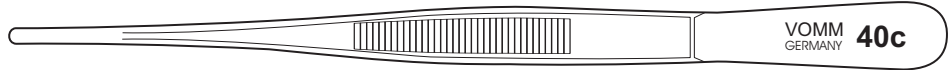
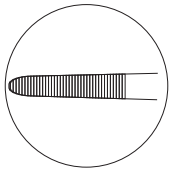

40c 3009 **8,28 €** Universalpinzette, 2 mm schmale, fein gezahnte Spitzen
Universal Tweezer, narrow 2 mm wide, fine serrated points 130 mm

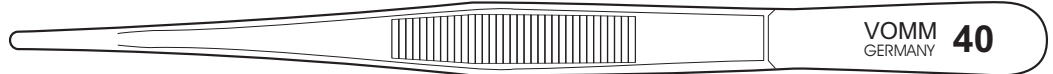
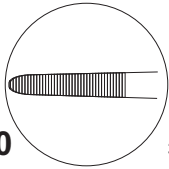

40	3010	8,28 €	Vernickelt	Nickel-plated	145 mm
47	3311	11,00 €	Vernickelt	Nickel-plated	180 mm
42	3110	13,66 €	Vernickelt	Nickel-plated	200 mm
48	3312	20,44 €	Vernickelt	Nickel-plated	250 mm
46	3310	25,08 €	Vernickelt	Nickel-plated	300 mm
44 SA	3210	10,46 €	Rostfrei, antimagnetisch	Stainless, antimagnetic	120 mm
44 S	3214	10,34 €	Rostfrei, gehärtet	Stainless, hardened	120 mm
40 SA	3014	11,30 €	Rostfrei, antimagnetisch	Stainless, antimagnetic	145 mm
40 SA-ESD	3606	11,84 €	Wie 40 SA, jedoch ESD-beschichtet	Same as 40 SA, but ESD-coated	145 mm
69 SA	3019	20,26 €	Rostfrei, antimagnetisch	Stainless, antimagnetic	200 mm
71 S	4412	23,36 €	Rostfrei, gehärtet	Stainless, hardened	250 mm

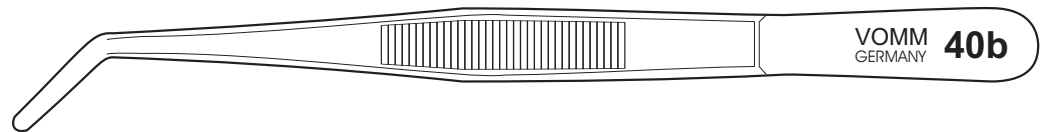
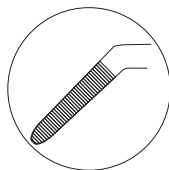

40b	3011	8,96 €	vernickelt	nickel-plated	145 mm
42b	3111	14,50 €	vernickelt	nickel-plated	200 mm
44b SA	3211	11,30 €	Rostfrei, antimagnetisch	Stainless, antimagnetic	120 mm

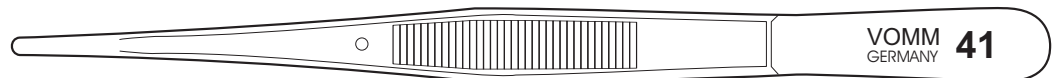
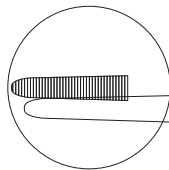

Mit Führungsstift with guide-pin

41	3012	10,30 €	vernickelt	nickel-plated	145 mm
43	3112	15,34 €	vernickelt	nickel-plated	200 mm
45 SA	3212	11,80 €	Rostfrei, antimagnetisch	Stainless, antimagnetic	120 mm

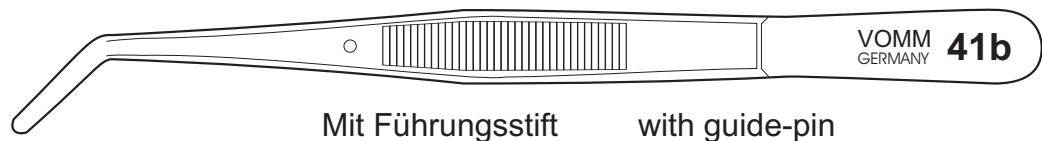
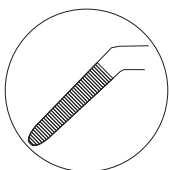

Mit Führungsstift with guide-pin

41b	3013	10,96 €	vernickelt	nickel-plated	145 mm
43b	3113	16,16 €	Vernickelt	nickel-plated	200 mm
45b SA	3213	12,64 €	Rostfrei, antimagnetisch	Stainless, antimagnetic	120 mm

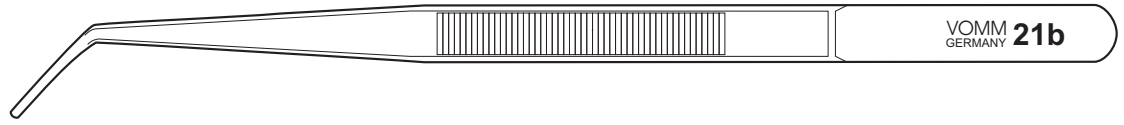
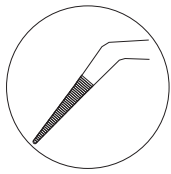

VOMM GERMANY **21b**

Preisgünstige Universalpinzette, geriefelte Spitzen

21b

9152

7,78 €

Low-Cost Tweezer, serrated points

155 mm

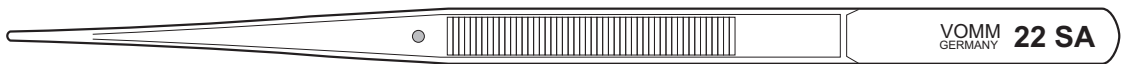
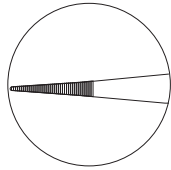

VOMM GERMANY **22 SA**

Mit Führungsstift

with guide-pin

22

9155

8,96 €

vernickelt

nickel-plated

155 mm

22 S

9156

10,30 €

dto., aber Rostfrei

same, but stainless

155 mm

22 SA

9159

11,66 €

dto., aber Antimagnetisch

same, but antimagnetic, stainless

155 mm

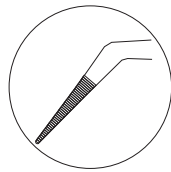

VOMM GERMANY **22b**

Mit Führungsstift

with guide-pin

22b

9153

9,26 €

wie Mod. 22, gebogen

same as Mod. 22, bent tips

155 mm

22b S

9154

10,96 €

wie Mod. 22 S, gebogen

same as Mod. 22 S, bent tips

155 mm

22b SA

9160

11,96 €

wie Mod. 22 SA, gebogen

same as Mod. 22 SA, bent tips

155 mm

No Nickel-Allergy!

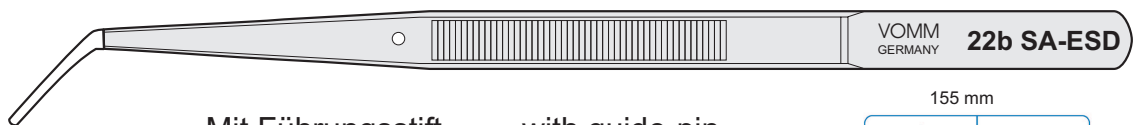

VOMM GERMANY **22b SA-ESD**

155 mm

Mit Führungsstift

with guide-pin

22b SA-ESD

3632

12,04 €

wie Modell 22b SA, jedoch ESD-beschichtet

22 SA-ESD

3607

10,40 €

same as Model 22 SA, but ESD-coated

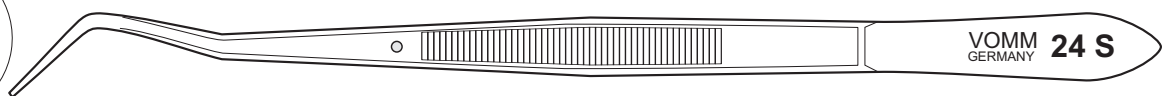
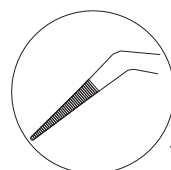

VOMM GERMANY **24 S**

Mit Führungsstift

with guide-pin

Typ Meriam, geriefelte Spitzen

24 S

9161

15,18 €

Meriam Type, serrated points

155 mm

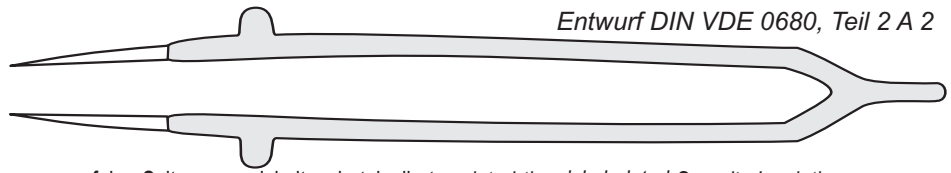

Entwurf DIN VDE 0680, Teil 2 A 2

AA SEC

8804

13,98 €

feine Spitzen, vernickelt, schutzisoliert *pointed tips/nickel-plated, Security-Insulation*

125 mm

AA SA-SEC

8805

16,52 €

(AA SA-SEC = Rostfrei, antimagnetisch) (AA SA-SEC = *Stainless, antimagnetic*)

125 mm

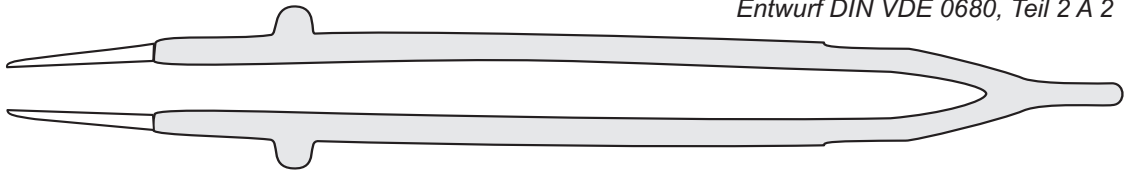
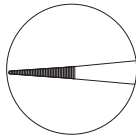

Entwurf DIN VDE 0680, Teil 2 A 2

22 SEC

8802

13,98 €

gerade, mittelfeine Spitzen, schutzisoliert (22b SEC=gebogen)

155 mm

22b SEC

8803

14,70 €

straight, medium pointed, Security-Insulation (22b SEC=bent)

155 mm

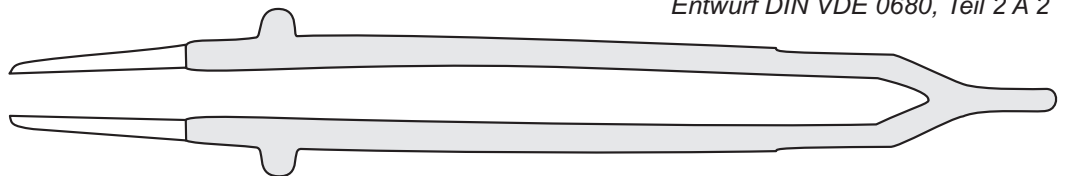
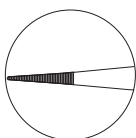

Entwurf DIN VDE 0680, Teil 2 A 2

40 SEC

8801

13,98 €

gerade, breite Spitzen, schutzisoliert

straight, blunt pointed, Security-Insulation

145 mm

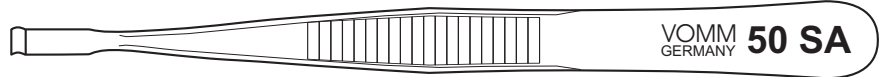
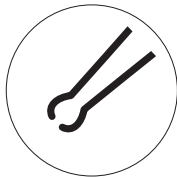

50 SA 2141 12,12 €

3 mm schmale Spitze, Aufnahme \varnothing 0,8 mm

3 mm wide tips, \varnothing 0.8 mm

120 mm

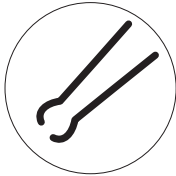

No Nickel-Allergy!



50 SA-ESD 3620 12,02 €

Wie 50 SA, jedoch ESD-beschichtet

Same as 50 SA, but ESD-coated

120 mm

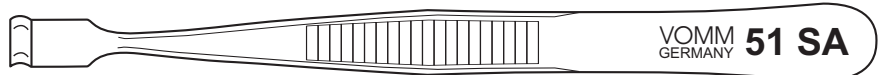
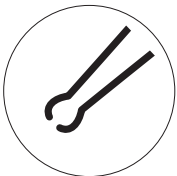

51 SA 2148 12,12 €

6.5 mm breite Spitze, Aufnahme \varnothing 1.5mm

6.5 mm wide tips, \varnothing 1.5 mm

120 mm

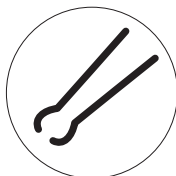

No Nickel-Allergy!

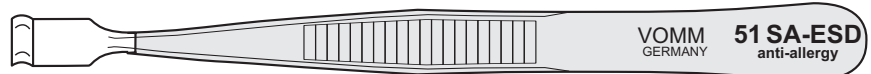

51 SA-ESD 3621 12,02 €

Wie 51 SA, jedoch ESD-beschichtet

Same as 51 SA, but ESD-coated

120 mm

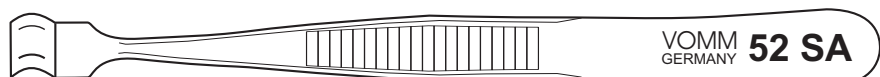
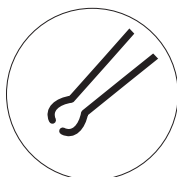

52 SA 2149 12,12 €

6.5 mm breite Spitze, Aufnahme \varnothing 3.5 mm

6.5 mm wide tips, \varnothing 3.5 mm

120 mm

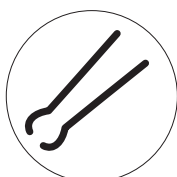

No Nickel-Allergy!

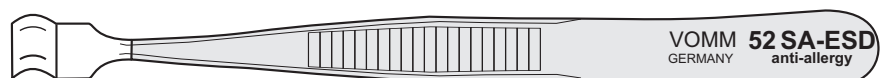

52 SA-ESD 3622 12,02 €

Wie 52 SA, jedoch ESD-beschichtet

Same as 52 SA, but ESD-coated

120 mm



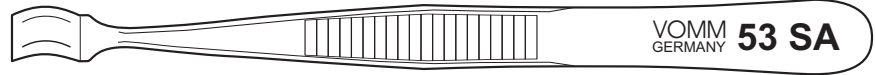
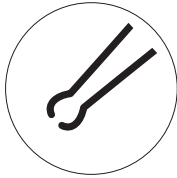

53 SA 2150 12,12 €

6.5 mm breite Spitze, Aufnahme \varnothing 6.5 mm

6.5 mm wide tips, \varnothing 6.5 mm

120 mm

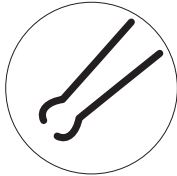

No Nickel-Allergy!

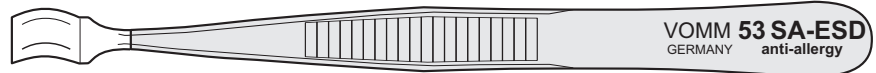

53 SA-ESD 3626 12,02 €

Wie 53 SA, jedoch ESD-beschichtet

Same as 53 SA, but ESD-coated

120 mm

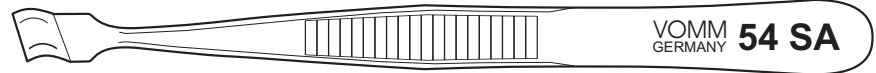
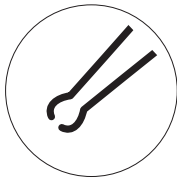

54 SA 2146 12,12 €

6.5 mm breite Spitze, diagonale Aufnahme \varnothing 3.5 mm

6.5 mm wide tips, \varnothing 3.5 mm diagonal

120 mm

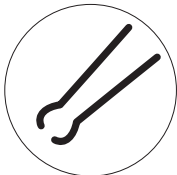

No Nickel-Allergy!

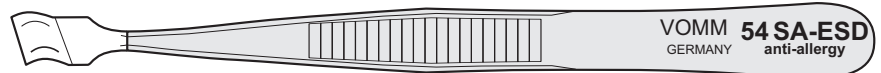

54 SA-ESD 3623 12,02 €

Wie 54 SA, jedoch ESD-beschichtet

Same as 54 SA, but ESD-coated

120 mm

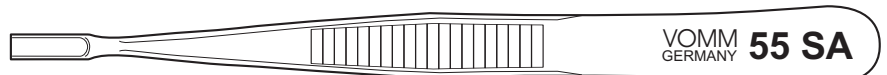
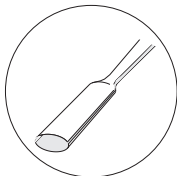

55 SA 2155 12,12 €

Aufnahme \varnothing 2.0 mm

\varnothing 2.0 mm

120 mm



56 SA 2151 12,12 €

Spitze 3 mm breit, flach

3 mm wide tips, flat

120 mm

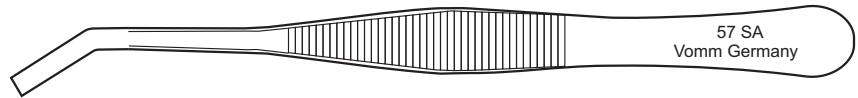
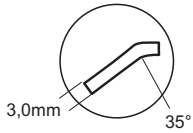

Wie 56 SA, 3mm breit, 35° gebogen

57 SA

2152

12,64 €

Same as 56 SA, 3mm wide, 35° bent

120 mm

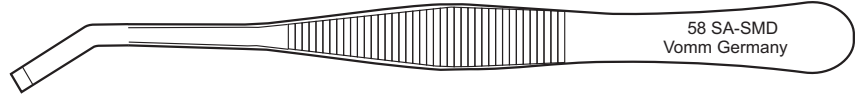
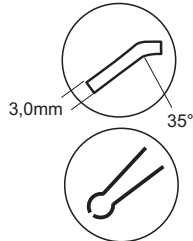

∅ 0.8 mm, 3mm breit, 35° gebogen

∅ 0.8 mm, 3mm wide, 35° bent

58 SA-SMD

2142

13,16 €

117 mm

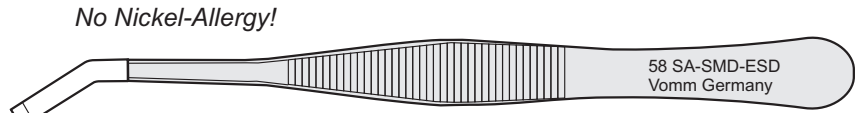
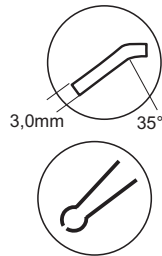

No Nickel-Allergy!

Wie 58 SA-SMD, jedoch ESD-beschichtet

Same as 58 SA-SMD, but ESD-coated



58 SA-SMD-ESD

3614

12,94 €

117 mm

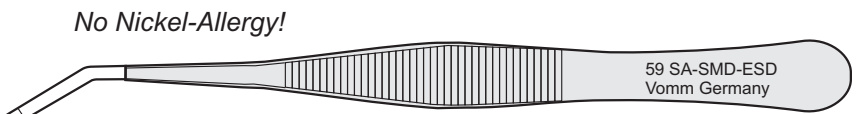
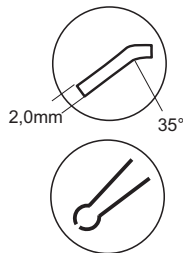

No Nickel-Allergy!

∅ 0.8 mm, 2mm breit, 35° gebogen

∅ 0.8 mm, 2mm wide, 35° bent

59 SA-SMD

2143

12,34 €

117 mm



59 SA-SMD-ESD

3603

12,94 €

Wie 59 SA-SMD, jedoch ESD-beschichtet

Same as 59 SA-SMD, but ESD-coated

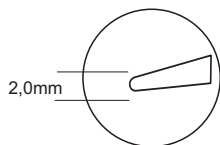

Stumpfe Leichtpinzette, sehr dünn

Blunt Light Tweezer, very thin

112 SA

9215

15,86 €

100 mm

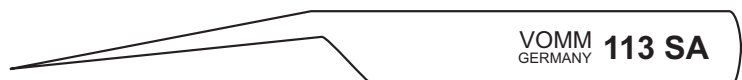
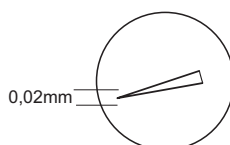

Spitze Leichtpinzette, sehr dünn

Pointed Light Tweezer, very thin

113 SA

9220

16,68 €

100 mm

114 SA

9221

24,02 €

Sporenpinzette microfeine Spitze

Tweezer for picking up spores Microfine tips

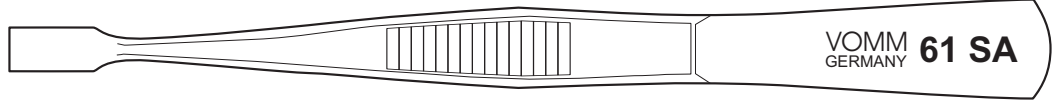
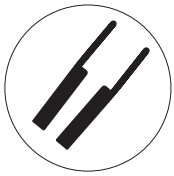

Wärmeableitpinzette mit Kupferbesatz

61 SA 3412 18,70 € *Heat-sinking Tweezer with copper-plated tips* 145 mm

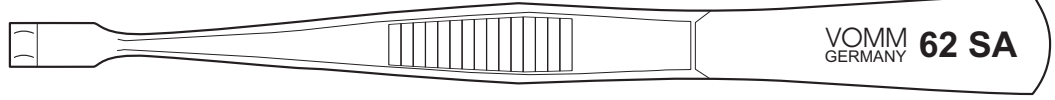
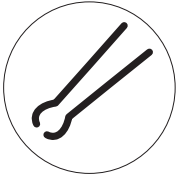

∅ 3,5 mm

62 SA 3416 14,32 € ∅ 3,5 mm 145 mm

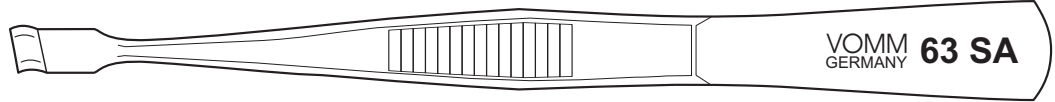
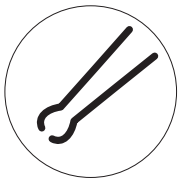

∅ 3,5 mm, diagonal

63 SA 3419 14,32 € ∅ 3,5 mm, diagonal 145 mm

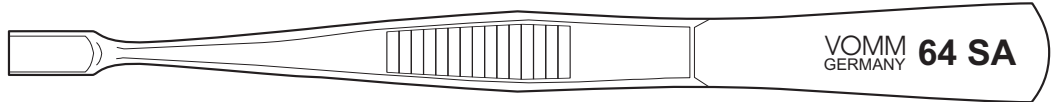
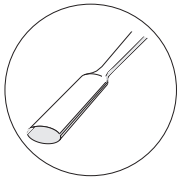

∅ 3,5 mm

64 SA 3414 14,32 € ∅ 3,5 mm 145 mm

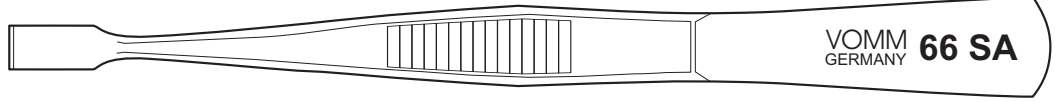
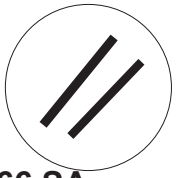

66 SA 3418 14,32 € flach *flat* 145 mm
66b SA 3411 22,44 € gebogen *bent* 145 mm

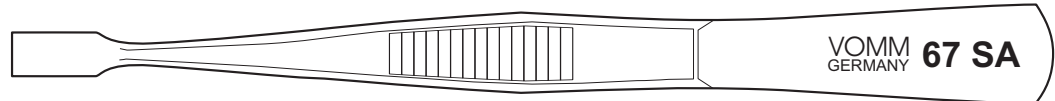
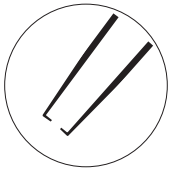

winklig

67 SA 3417 14,32 € *bent* 145 mm

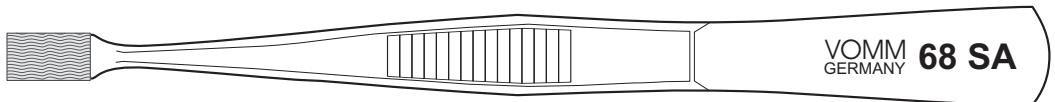
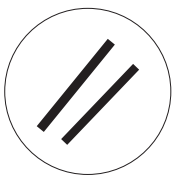

Spitze mit Silikon-Schutz

68 SA 3413 18,52 € *Silicone covered tips* 145 mm

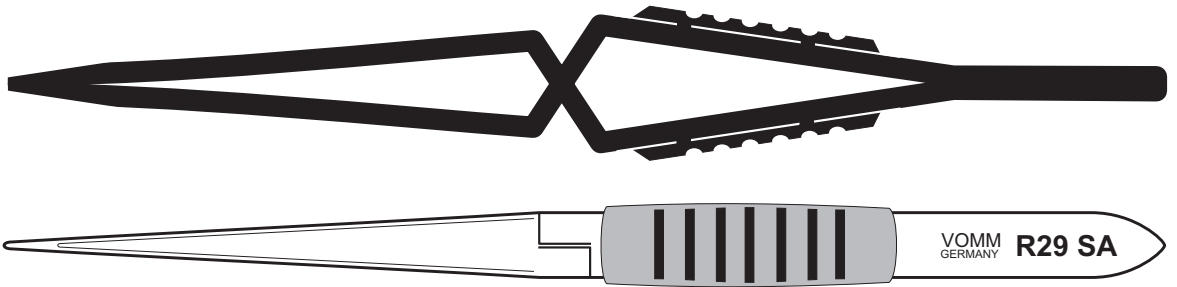

R29	3272	12,30 €	vernickelt	<i>nickel-plated</i>	160 mm
R29 SA	3270	14,50 €	Rostfrei, antimagnetisch	<i>stainless, antimagnetic</i>	160 mm

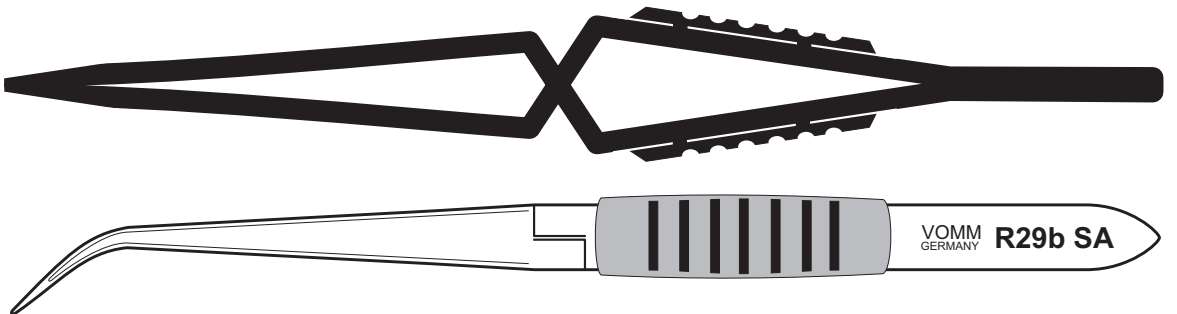

R29b	3273	13,16 €	vernickelt	<i>nickel-plated</i>	160 mm
R29b SA	3271	15,34 €	Rostfrei, antimagnetisch	<i>stainless, antimagnetic</i>	160 mm
R29b SA-T	3276	24,50 €	Wie R29b SA jedoch ganz Teflon beschichtet	<i>Same as R29b SA, but coated with Teflon</i>	160 mm

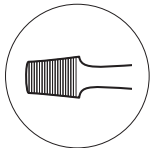
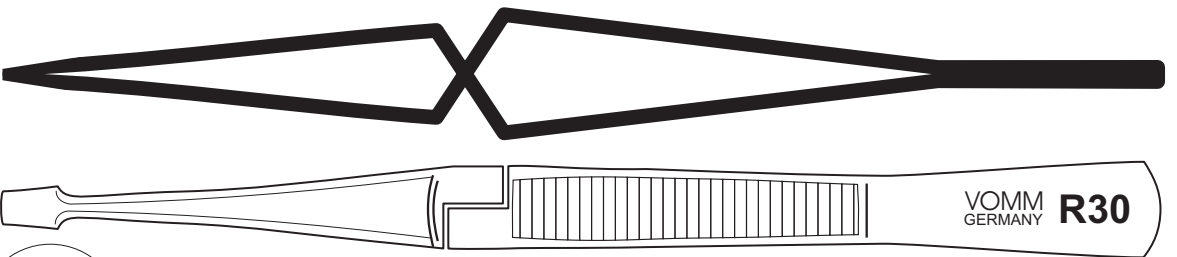

R30	8075	11,80 €	vernickelt, Spitze fein gezahnt	<i>nickel-plated, with fine serration</i>	160 mm
------------	------	----------------	---------------------------------	---	--------

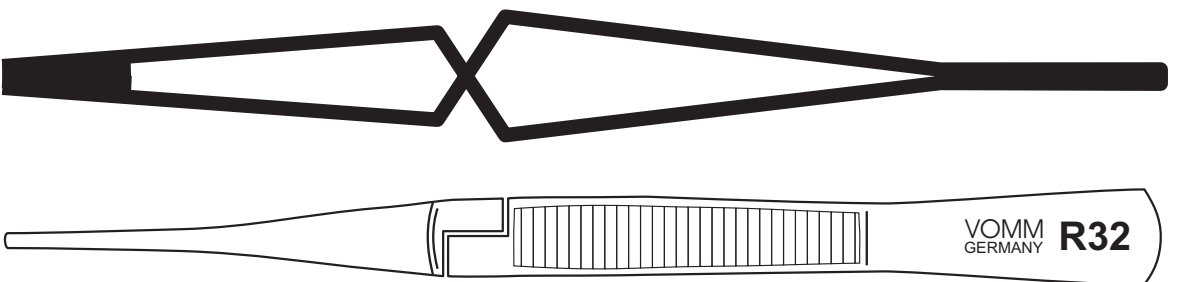

R32	3275	18,36 €	Wärmeableit-Kreuzpinzette, vernickelt <i>Heat-sinking, reversible Tweezer, nickel-plated</i>		160 mm
------------	------	----------------	---	--	--------

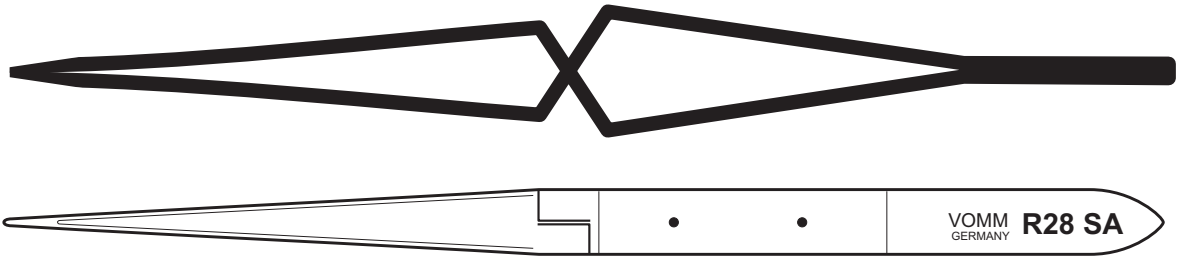

R28 SA 3274 11,52 € Rostfrei, antimagnetisch Preisgünstige Ausführung 160 mm
stainless, antimagnetic Low-cost, nickel-plated

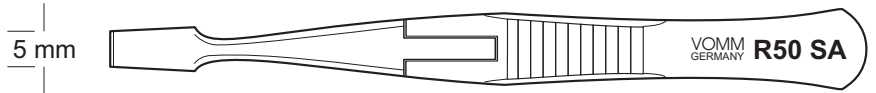

R50 SA 8050 18,04 € Deckglaspinzette *Cover-Glass Tweezer* 105 mm
R50b SA 8051 20,02 € Dto., gebogen *same, bent* 105 mm

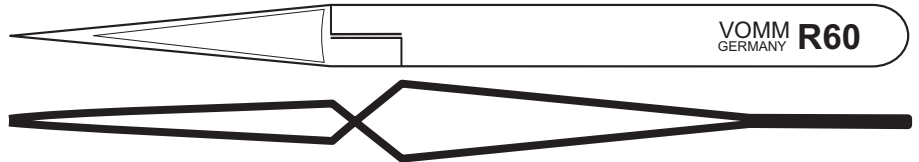

R60 8060 12,12 € vernickelt, selbstklemmend *Nickel-plated, reversible function* 120 mm
R61 8061 13,34 € Wie R60, jedoch länger *Same as R60, but longer* 160 mm

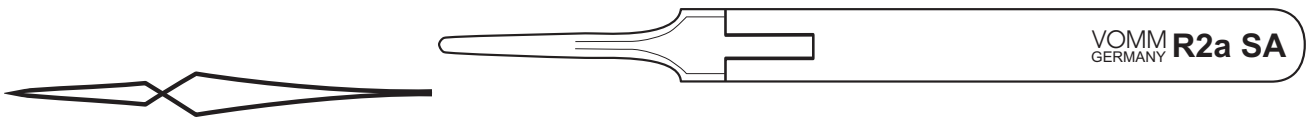

R2a SA 5802 16,52 € Wie 2a SA, jedoch als durchgesteckte Kreuzpinzette
Same as 2a SA, but self-locking and box-joint 115 mm



R3 SA 5803 16,52 € Wie 3 SA, jedoch als durchgesteckte Kreuzpinzette
Same as 3 SA, but self-locking and box-joint 115 mm

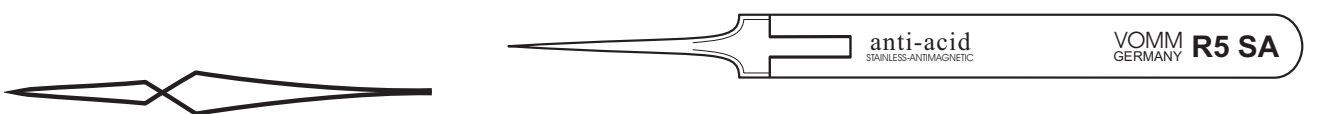

R5 SA 5805 16,52 € Wie 5 SA, jedoch als durchgesteckte Kreuzpinzette
Same as 5 SA, but self-locking and box-joint 105 mm



R7a SA

5807

19,86 €

Wie 7a SA, jedoch als durchgesteckte Kreuzpinzette

Same as 7a SA, but self-locking and box-joint

115 mm

auch einzeln erhältlich, siehe B.-Nr. und Einzelpreis

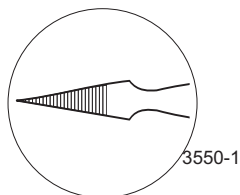

Spitzen aus 3550-2

KERAMIK

Ceramic Tips

3550-3



112,90 €

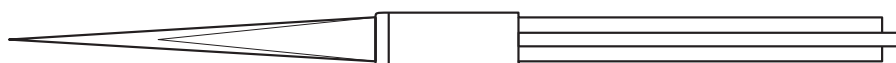

118,78 €

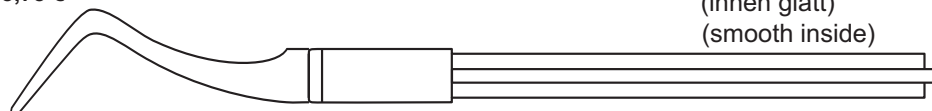

(innen glatt)
(smooth inside)

134,64 €

Satz von 3 versch. Keramikpinzetten mit Kunststoffgriff

130 mm

CERAMset

3550

299,48 €

Set of 3 different Ceramic Tweezers with handles made of Polyacetal

Massive

KERAMIK

Solid Ceramic



Original **VOMM**[®]
FINE CERAMIC TWEEZER



Original **VOMM**[®]
FINE CERAMIC TWEEZER

AA CER

8502

87,90 €

Spitze 1 mm breit, glatt

Tips 1 mm width, smooth

125 mm

PSF CER

8501

87,90 €

Wie AA CER, jedoch gezahnt

Same as AA CER, but serrated

125 mm

Massive

KERAMIK

Solid Ceramic



Original **VOMM**[®]
FINE CERAMIC TWEEZER

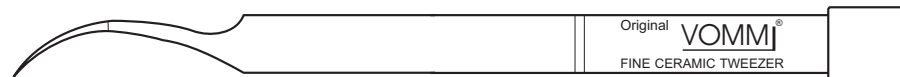

Original **VOMM**[®]
FINE CERAMIC TWEEZER

3 CER

8503

103,36 €

sehr spitz, glatt

very pointed, smooth

120 mm

7a CER

8507

111,08 €

Spitz, gebogen

Pointed, bent

125 mm

Klingen aus

KERAMIK

Ceramic Blades

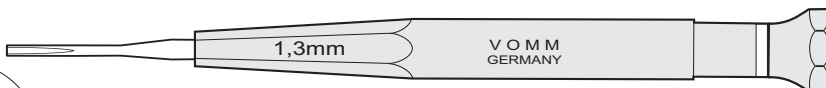
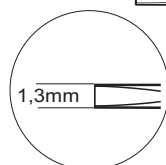

Antistatisch-schwarz

Antistatic-black

TRIM 09

6409-A

22,24 €

0.9 x 0.4 x 30 mm

110 mm

TRIM 13

6413-A

22,24 €

1.3 x 0.4 x 30 mm

110 mm

TRIM 18

6418-A

22,24 €

1.8 x 0.4 x 30 mm

110 mm

TRIM 30

6430-A

22,24 €

3.0 x 0.4 x 30 mm

110 mm

TRIM 0

6401-A

27,26 €

Philips 0

110 mm

TRIM 1

6402-A

27,26 €

Philips 0 special

110 mm

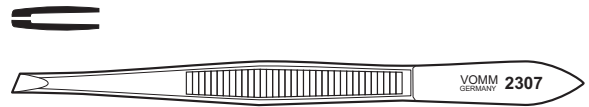
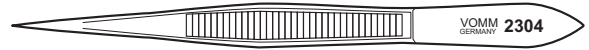
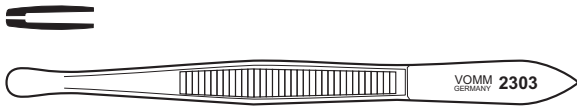

2301	8,80 €	Rostfreier Stahl
2302	8,80 €	dito
2303	8,80 €	dito
2304	8,80 €	dito
2306	8,80 €	dito
2307	8,80 €	dito

<i>Stainless Steel</i>	2301	80 mm
<i>same</i>	2302	80 mm
<i>same</i>	2303	80 mm
<i>same</i>	2304	80 mm
<i>same</i>	2306	80 mm
<i>same</i>	2307	80 mm

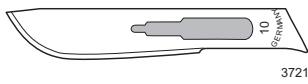

3721

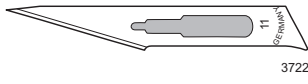

3722

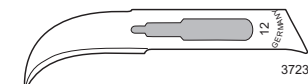

3723

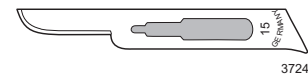

3724

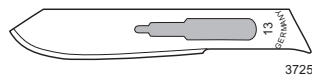
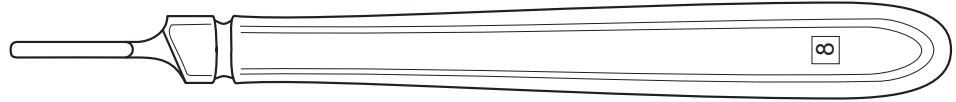
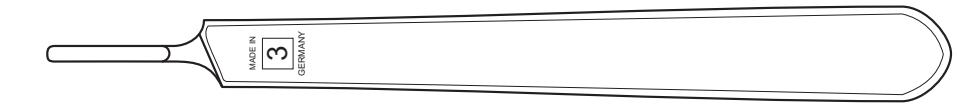

3725

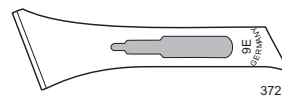

3727

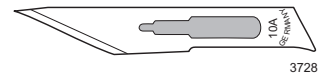

3728

3	3730	7,14 €	Standard-Skalpellgriff, verchromt	<i>Scalpel-Handle, chrome-plated</i>	124 mm
8	3719	34,66 €	Hohlheft-Skalpellgriff	<i>Hollow Scalpel-Handle</i>	129 mm
	3721-3728	0,86 €	Skalpellklingen (Preis/Stück)	<i>Scalpel-Blades (price/piece)</i>	

Klingen 5950 5,08 € Paar von Ø 0,2mm bis Ø 1,2mm Blades - Pair - from Ø 0,2mm up to Ø 1,2mm

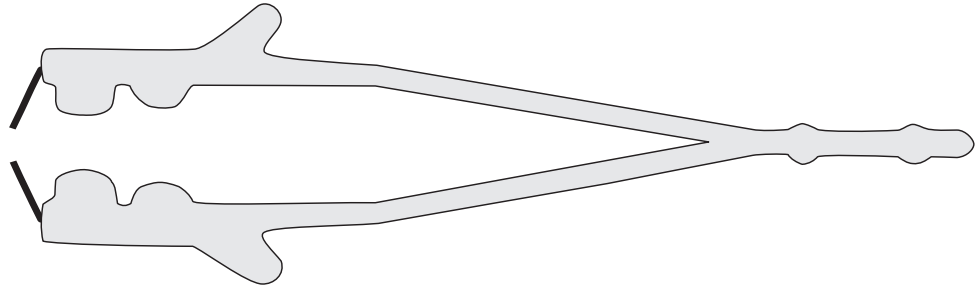

Lackabkratzer für isolierte Drähte
Wire-Scraper

WS2 6000 21,04 € 130 mm

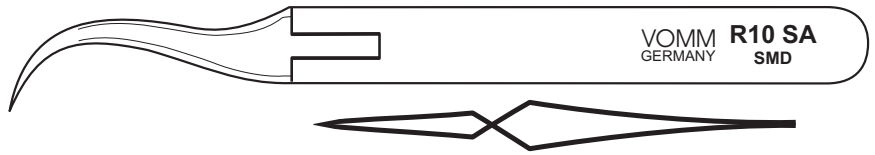

Für SMD-Chips, durchgesteckt und selbstklemmend
For SMT-Chips, reversible-function and box-joint

6610 28,68 € **R10 SA-SMD** 117 mm

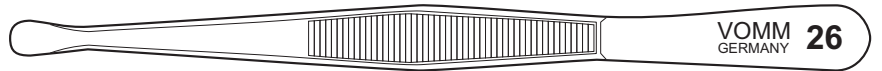

Runde, dünne Spitzen
Round and flat tips

26 3350 6,60 € 120 mm

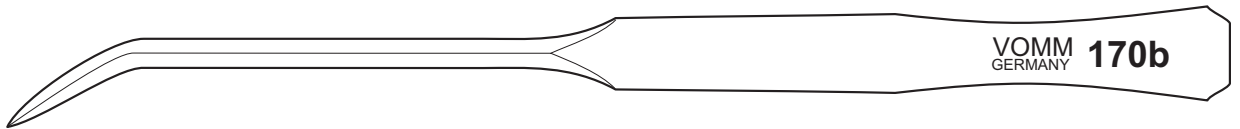

170	3280	11,96 €	vernickelt, gerade	Nickel-plated, straight	170 mm
170b	3281	12,64 €	dto., gebogen	same, but bent	170 mm



80	9551	4,42 €	Blechpinzette, vernickelt	Low-Cost, nickel-plated	120 mm
81	9552	5,08 €	Wie 80, nur länger	Same as 80, but longer	140 mm
82	9553	5,60 €	Wie 80, nur länger	Same as 80, but longer	160 mm



80L	9366	8,44 €	Mit Feststellschieber, vernickelt	With Slide-Lock, nickel-plated	120 mm
82L	9367	9,78 €	Wie 80L, nur länger	Same as 80L, but longer	160 mm

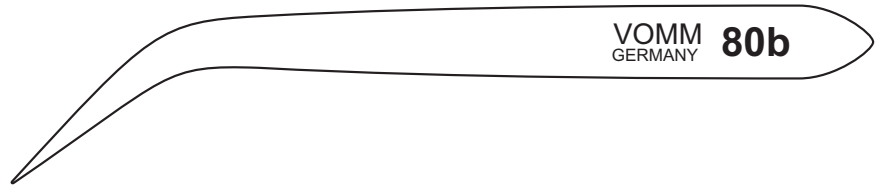

80b	8000	5,60 €	Vernickelt	Nickel-plated	120 mm
------------	------	---------------	------------	---------------	--------

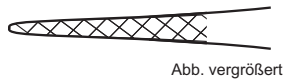
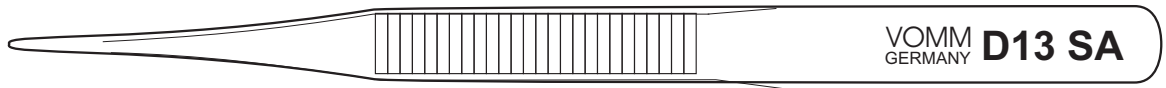

D11	9710	8,44 €	Vernickelt	Nickel-plated	120 mm
D12	9712	9,26 €	Vernickelt	Nickel-plated	140 mm
D13	9714	11,44 €	Vernickelt	Nickel-plated	160 mm
D11 S	9711	10,46 €	Wie D11, jedoch rostfrei	Same as D11, but Stainless	120 mm
D12 S	9713	11,80 €	Wie D12, jedoch rostfrei	Same as D12, but Stainless	140 mm
D13 S	9716	12,30 €	Wie D13, jedoch rostfrei	Same as D13, but Stainless	160 mm
D13 SA	9709	13,16 €	Wie D13 S, jedoch antimagnetisch	Same as D13 S, but antimagnetic	160 mm

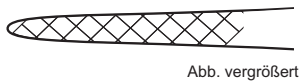
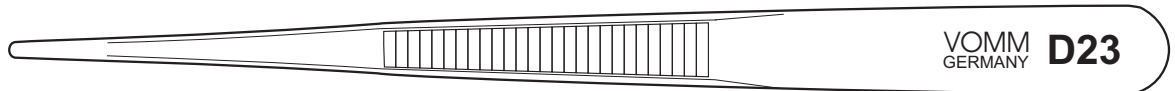

D21	9717	8,44 €	Vernickelt	Nickel-plated	120 mm
D22	9719	9,26 €	Vernickelt	Nickel-plated	140 mm
D23	9721	11,66 €	Vernickelt	Nickel-plated	160 mm
D21 S	9718	10,30 €	Wie D21, jedoch rostfrei	Same as D21, but Stainless	120 mm
D22 S	9720	11,66 €	Wie D22, jedoch rostfrei	Same as D22, but Stainless	140 mm
D23 S	9722	12,30 €	Wie D23, jedoch rostfrei	Same as D23, but Stainless	160 mm

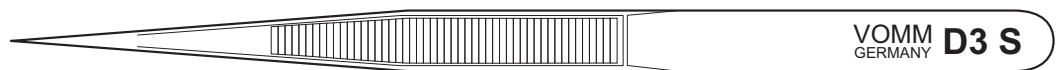

D3	9723	10,12 €	Sehr spitz, vernickelt	Very pointed, nickel-plated	140 mm
D3 S	9724	12,48 €	Wie D3, jedoch rostfrei	Same as D3, but Stainless	140 mm

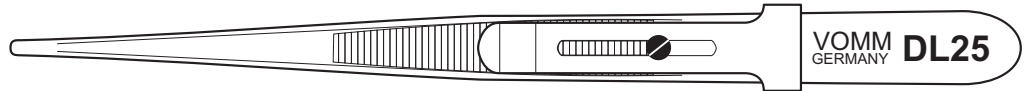
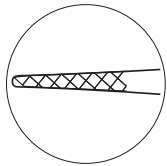

DL15	9715	22,02 €	Mit Feststellschieber, vernickelt	<i>With Slide-Lock, nickel-plated</i>	160 mm
DL25	9725	20,78 €	Wie DL15, nur kürzer	<i>Same as DL15, but shorter</i>	140 mm



19 SA-SMD	6619	16,60 €	Mit Einfräsung, \varnothing 0,5mm	<i>With milled slot, \varnothing0,5 mm</i>	120 mm
------------------	------	----------------	-------------------------------------	---	--------



D	6500	14,32 €	Schneidepinzette	<i>Cutting-Tweezer</i>	95 mm
----------	------	----------------	------------------	------------------------	-------

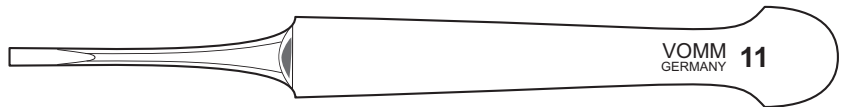

Glatte Greiffläche



11	8600	11,80 €	Vernickelt	<i>Nickel-plated</i>	115 mm
-----------	------	----------------	------------	----------------------	--------

Glatte Greiffläche

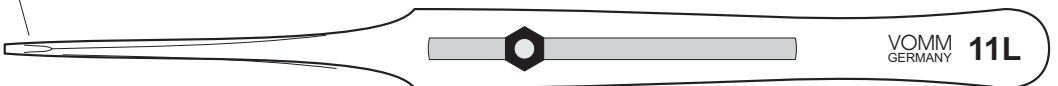

11L	8610	19,38 €	Mit Feststellschieber, vernickelt	<i>With slide-lock, nickel-plated</i>	145 mm
------------	------	----------------	-----------------------------------	---------------------------------------	--------

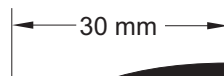

110 SA	9210	17,20 €	Wägepinzette, Spitze aus Kunststoff	<i>Weight Tweezer, Plastic Tips</i>	95 mm
---------------	------	----------------	-------------------------------------	-------------------------------------	-------



0450 **11,66 €** Kunststoffgriff, Spiegel Ø14 mm *Plastic handle, mirror Ø14 mm* 165 mm

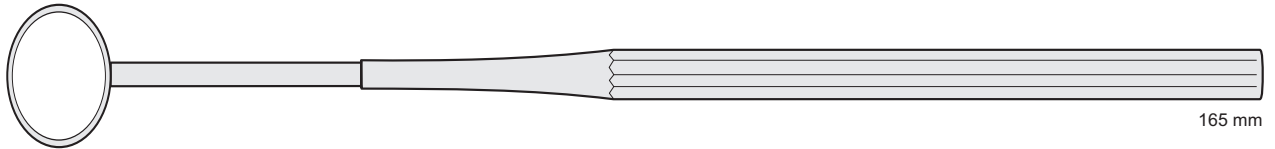

0455 **16,28 €** Rostfreier Griff, Spiegel Ø20 mm *Stainless Steel handle, mirror Ø20 mm*

0456 **9,58 €** Griff Vernickelt, Spiegel Rostfrei Ø20 mm
Nickel-plated handle, Stainless steel mirror Ø20 mm

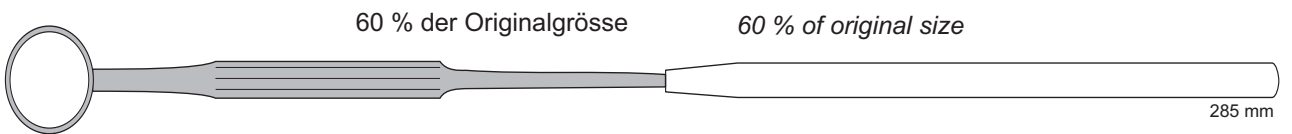

0460 **13,16 €** Kunststoff, 2-teiliger Griff, Spiegel Ø18 mm *Plastic, handle consists of 2 parts, mirror Ø18 mm*

0466 **59,06 €** Vernickelt, Teleskopgriff, Spiegel Ø18 mm und verstellbar
Nickel-plated, telescope-handle, adjustable mirror Ø18 mm

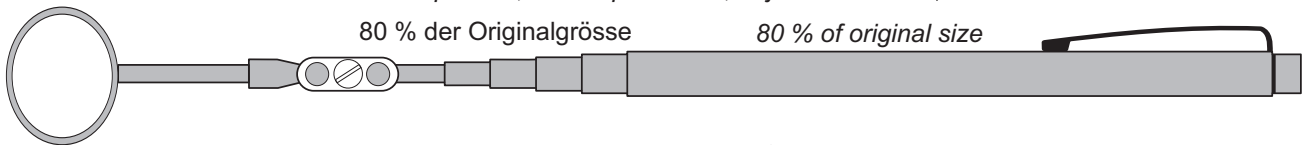

0468 **76,40 €** Vernickelt, Teleskopgriff, Spiegel Ø60 mm und verstellbar
Nickel-plated, telescope-handle, adjustable mirror Ø60 mm 10 -300 mm

Griffe können individuell bestückt werden
85 % der Originalgröße

Handles can be equipped individually
85 % of original size

	0410	18,58 €	Ø 10 mm	175 mm
	0414	18,58 €	Ø 14 mm	180 mm
	0416	18,58 €	Ø 16 mm	180 mm
	0418	18,58 €	Kehlkopfspiegel Ø 18 mm	180 mm
	0420	15,80 €	Ø 20 mm	180 mm
	0422	15,80 €	Laryngoscopes Ø 22 mm	180 mm
	0424	15,80 €	Ø 24 mm	180 mm
	0426	15,80 €	Ø 26 mm	185 mm
	0428	18,58 €	Ø 28 mm	190 mm
	0430	18,58 €	Ø 30 mm	190 mm

Gesamtlängen
Total Lengths

Haken, Sonden, Excavatoren, Typ Dental, aus rostfreiem Stahl gehärtet für Arbeiten auf Leiterplatten, zum Modellieren

Hooks, probes and excavators, dental type, made of stainless steel hardened for works on PCB's, modelling

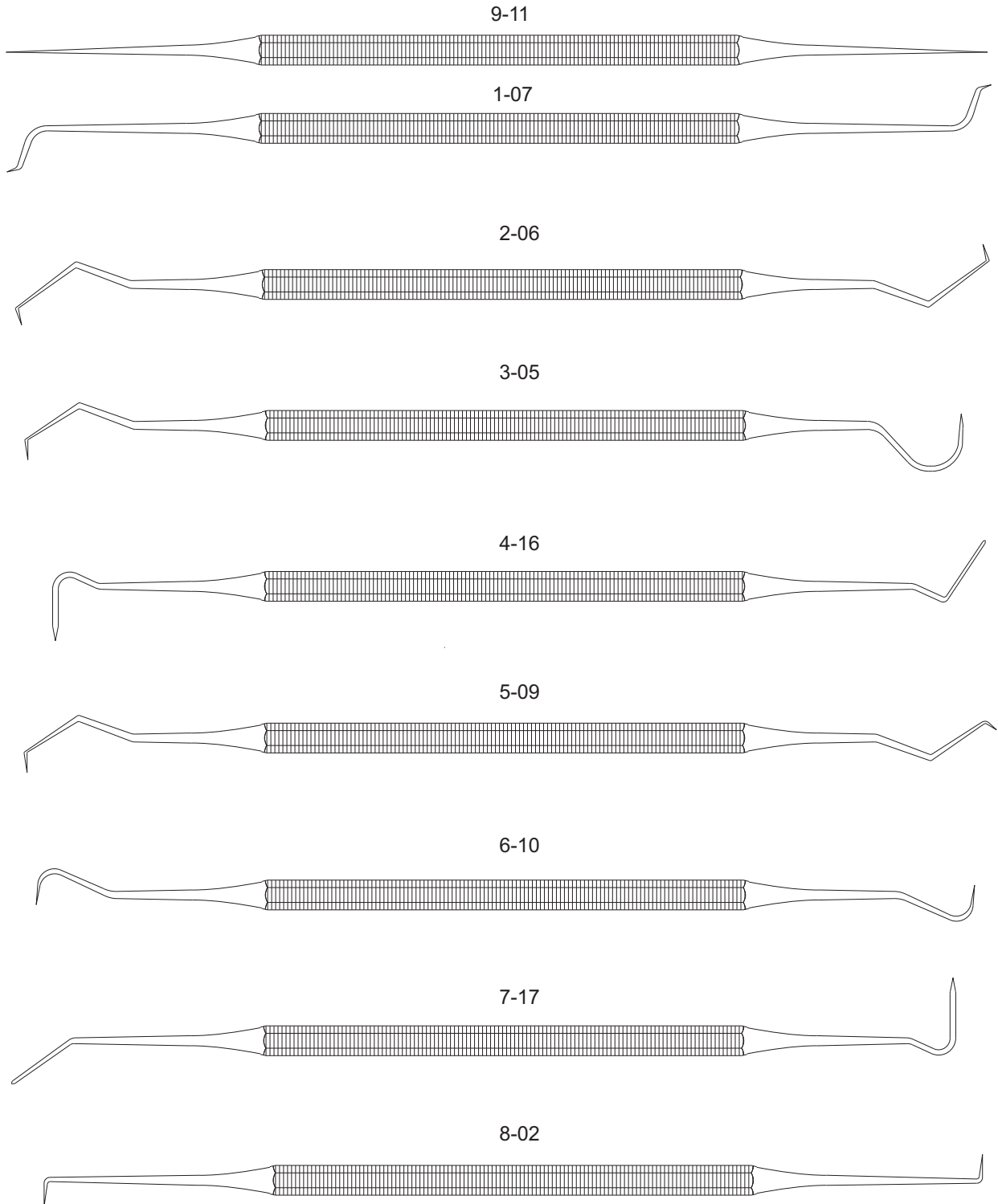

Sonden, 9-teiliger Satz, zum Hebeln und Entfernen von Bauteilen
 Modelle sind auch einzeln erhältlich (Art.-Nr. 3220 + Haken-Nr.)

Preis/Satz:
 Price/set: **133,04 €**

Art.-Nr. 3220

Preis/Stück: *Set of 9 probes, for levering and removing components*
 Price/piece: **15,52 €** *Models are also available separately (Art.-No. 3220 + hook no.)*

Haken, Sonden, Excavatoren, Typ Dental, aus rostfreiem Stahl gehärtet für Arbeiten auf Leiterplatten, zum Modellieren

Hooks, probes and excavators, dental type, made of stainless steel hardened for works on PCB's, modelling

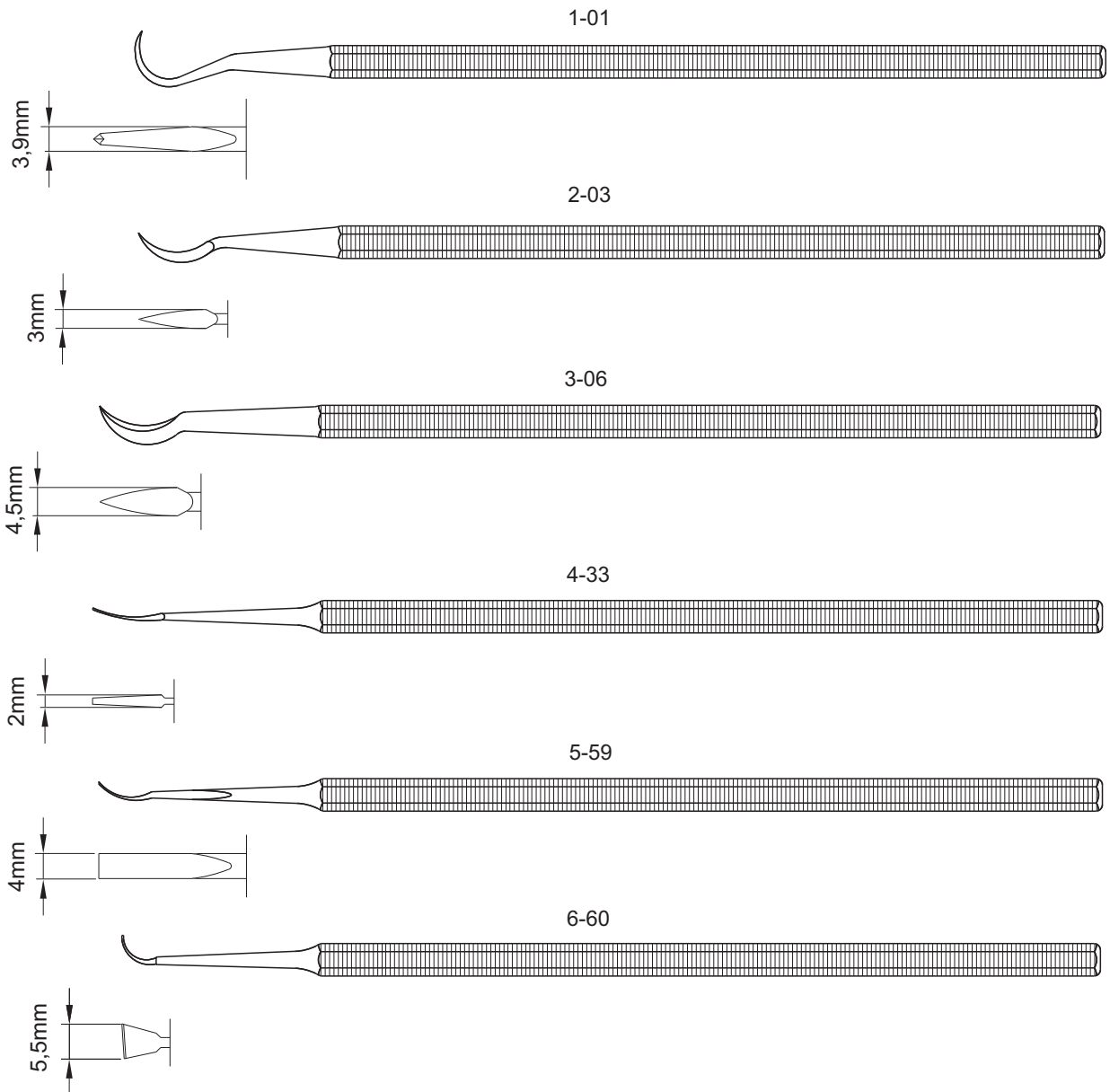

Art.-Nr. 3230

Haken, 6-teiliger Satz, scharf, für Leiterbahnen, zum Schneiden und Markieren.

Preis/Satz:

Haken sind auch einzeln erhältlich (Art.-Nr. 3230 + Haken-Nr.)

Price/set: **123,44 €**

Preis/Stück:

Set of 6 hooks, sharp, for printed conductors, for cutting and marking

Price/piece: **21,16 €**

Models are also available separately (Art.-No. 3230 + hook no.)

Mikrospatel

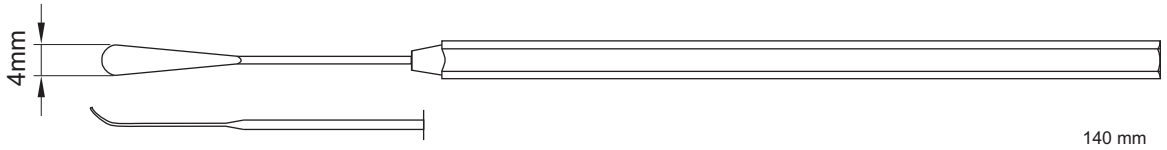

3240

11,66 €

Mikrospatel aus Chrom/Nickel-Edelstahl, löffelförmig, 4mm breit
Micro-spatula of Chrome/Nickel-Steel, spoon-shaped, 4mm wide

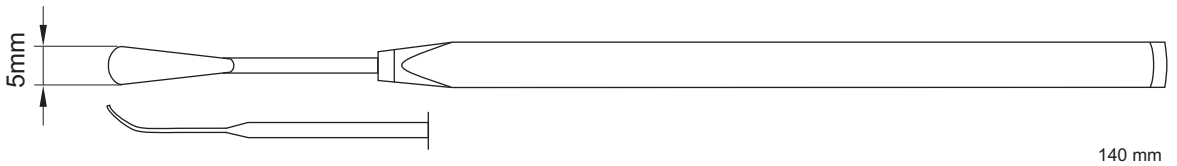

3241

11,66 €

Mikrospatel aus Chrom/Nickel-Edelstahl, löffelförmig, 5mm breit
Micro-spatula of Chrome/Nickel-Steel, spoon-shaped, 5mm wide

Sonderausführungen:
 universal verwendbare Teile

Special models:
 multi-purpose versatility

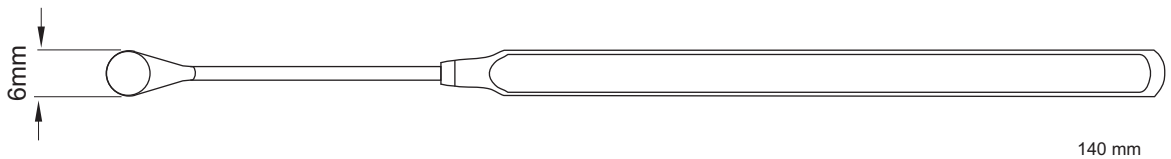

3245

14,06 €

Mikrolöffelchen aus Chrom/Nickel-Edelstahl, 5mm breit
Micro-spoon of Chrome/Nickel-Steel, 5mm wide

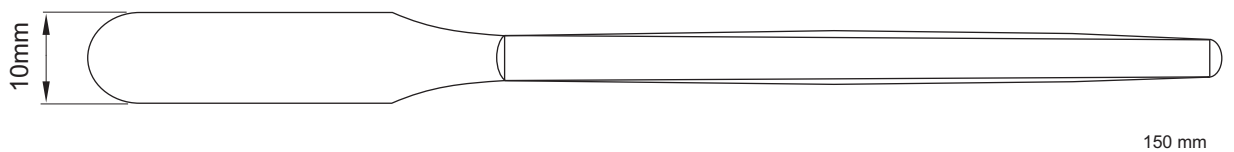

3254

14,06 €

Spatel aus Chrom/Nickel-Edelstahl, 10mm breit
Spatula of Chrome/Nickel-Steel, 10mm wide



3221

13,62 €

Löthaken aus Chrom/Nickel-Edelstahl, für Kabel und Drähte
Soldering hook of Chrome/Nickel-Steel for cables and wires

165 mm

Spezial: Microspatel

sehr leichte Ausführung/ präzise arbeitend

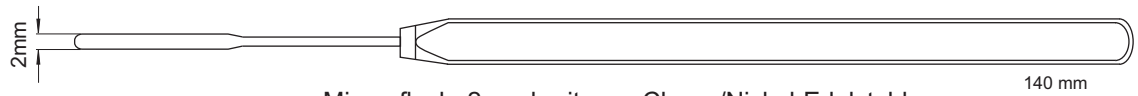

3250

13,62 €

Micro, flach, 2mm breit, aus Chrom/Nickel-Edelstahl

Micro, flat, 2mm wide, of Chrome/Nickel-Steel

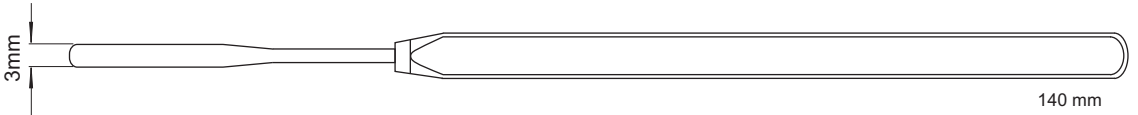

3251

13,62 €

Micro, flach, 3mm breit, aus Chrom/Nickel-Edelstahl

Micro, flat, 3mm wide, of Chrome/Nickel-Steel



3252

13,62 €

Micro, flach, 4mm breit, aus Chrom/Nickel-Edelstahl

Micro, flat, 4mm wide, of Chrome/Nickel-Steel

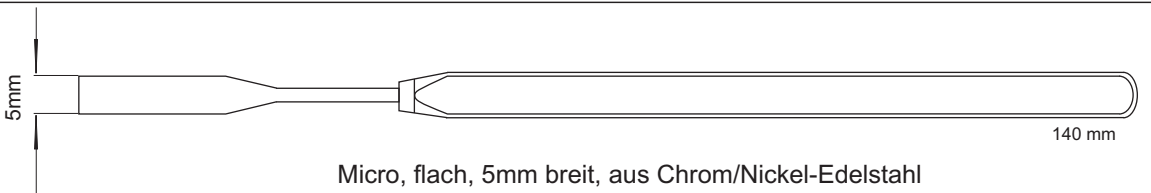

3253

13,62 €

Micro, flach, 5mm breit, aus Chrom/Nickel-Edelstahl

Micro, flat, 5mm wide, of Chrome/Nickel-Steel

Pulverspatel winklige Ausführung, längs hohlgeformt

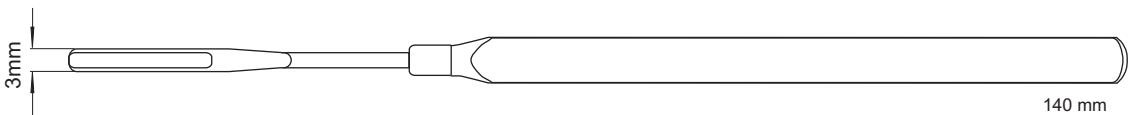

3260

14,90 €

Micro, winklig, hohl, 3mm breit, aus Chrom/Nickel-Edelstahl

Micro, twisty, concave, 3mm wide, of Chrome/Nickel-Steel

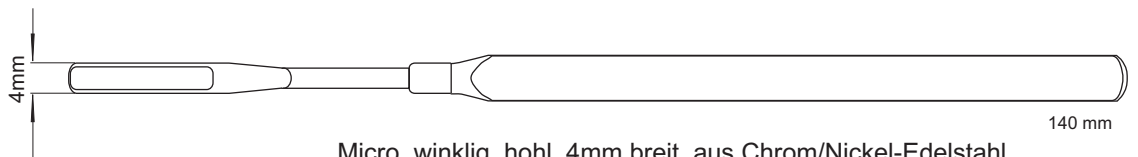

3261

14,90 €

Micro, winklig, hohl, 4mm breit, aus Chrom/Nickel-Edelstahl

Micro, twisty, concave, 4mm wide, of Chrome/Nickel-Steel

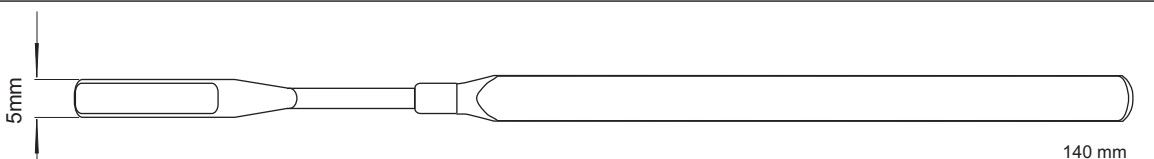

3262

14,90 €

Micro, winklig, hohl, 5mm breit, aus Chrom/Nickel-Edelstahl

Micro, twisty, concave, 5mm wide, of Chrome/Nickel-Steel

Langer Bogen 10mm
Long bent 10mm

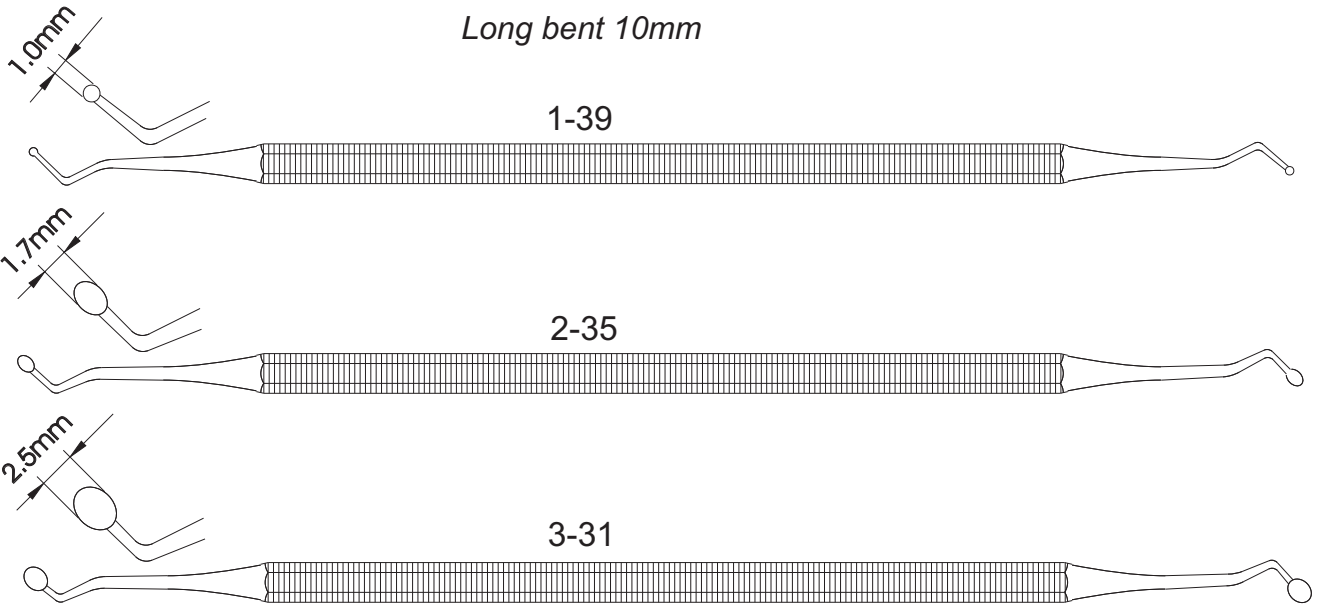

Kurzer Bogen 8mm
Short bent 8mm

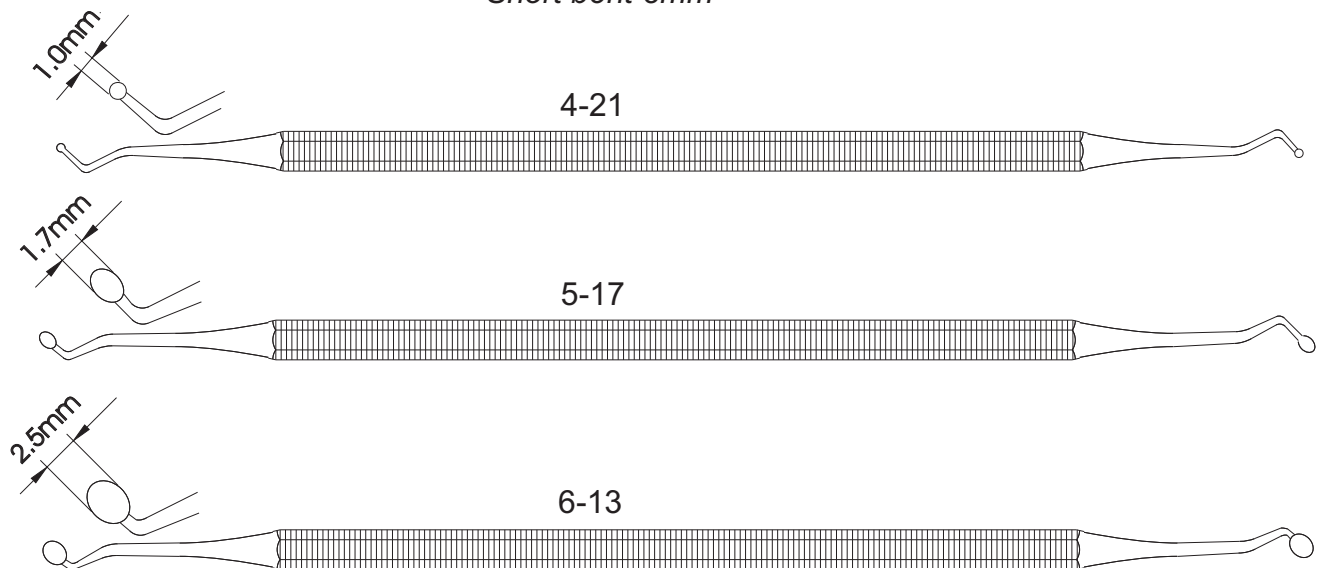

3225

Preis/Satz

Price/Set 122,14 €

Excavatoren, aus rostfreiem Stahl gehärtet, 6-teiliger Satz, als Mini-Spatel verwendbar
Modelle sind auch einzeln erhältlich (Art.-Nr. + Spiegel-Nr.)

Preis/Stk.

Price/Piece 21,68 €

Set of 6 excavators, of stainless steel hardened, can be used as mini-spatulas
Models are also available separately (Art.-No. + mirror-No.)

Nichtmetallische Handwerkzeuge

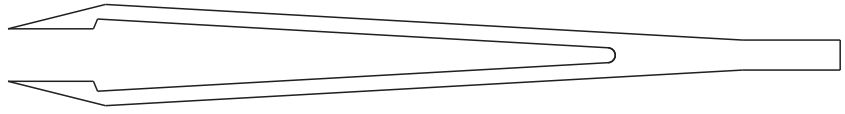
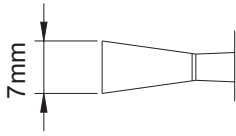

110mm
4 1/2 inch

03 5300 7,76 €

Dünne, 7mm breite Spitze, Delrin, glasfaserverstärkt
7mm wide, thin points, glass-filled Delrin

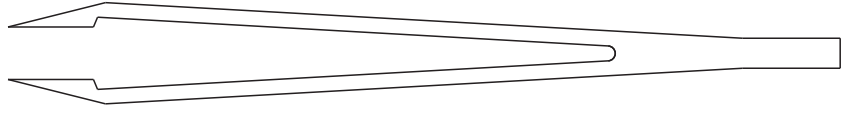
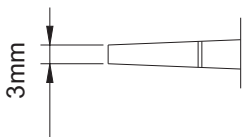

110mm
4 1/2 inch

100 5322 6,02 €

Dünne, flach-breite Spitze, 3mm breit, Delrin, glasfaserverstärkt
Thin tips, 3mm wide, glass-filled Delrin

100-AS 5323 8,06 €

Dito, jedoch aus leitfähiger CARBON-Faser
Same, but made of conductive Carbon Fibre

100-1 5324 7,38 €

Dito, jedoch aus linearem Polyethylen, säurefest
Same, but made of linear polyethylene, acid-resistant

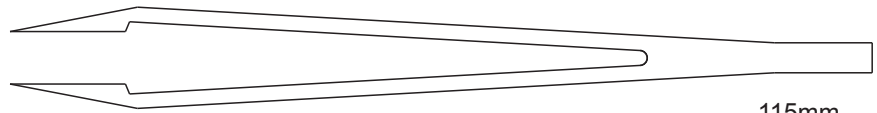
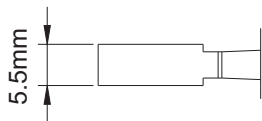

115mm
4 1/2 inch

04 5336 7,06 €

Dünne Spitze, 5,5mm breit, Delrin, glasfaserverstärkt
Flat points, 5,5mm wide, glass-filled Delrin

05 5338 7,04 €

7,5mm breit/wide

06 5302 7,04 €

9mm breit/wide

07 5304 7,38 €

12mm breit/wide



04-1 5337 7,38 €

Dito, jedoch aus säurebeständigem Polyethylen
Same, but made of acid-resistant Polyethylene

05-1 5339 7,76 €

7,5mm breit/wide

06-1 5303 7,76 €

9mm breit/wide

07-1 5305 8,06 €

12mm breit/wide



Nichtmetallische Handwerkzeuge

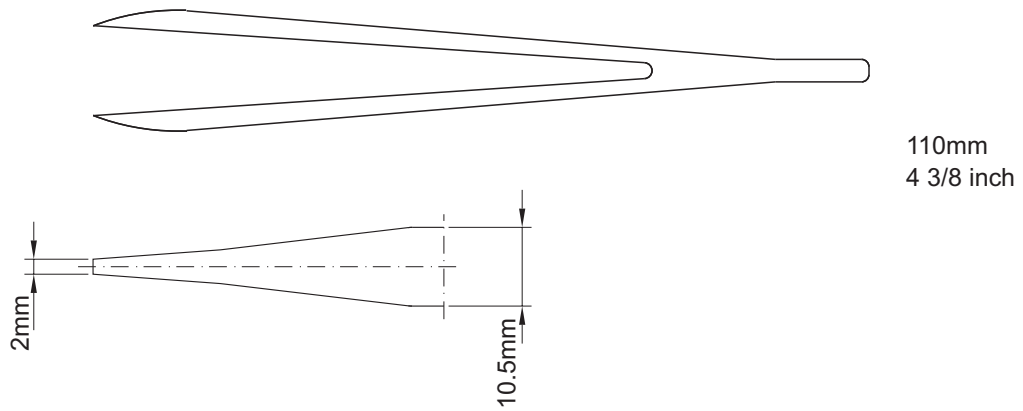

1A	5315	15,06 €	Starke Spitze, 3mm breit, CTFE, säurebeständig, 200°C <i>Strong points, 3mm wide, CTFE, acid-resistant, 200°C</i>
1A-1	5314	15,36 €	dito, jedoch mit Riefelung an den Innenspitzen <i>same, but with serrated points</i>

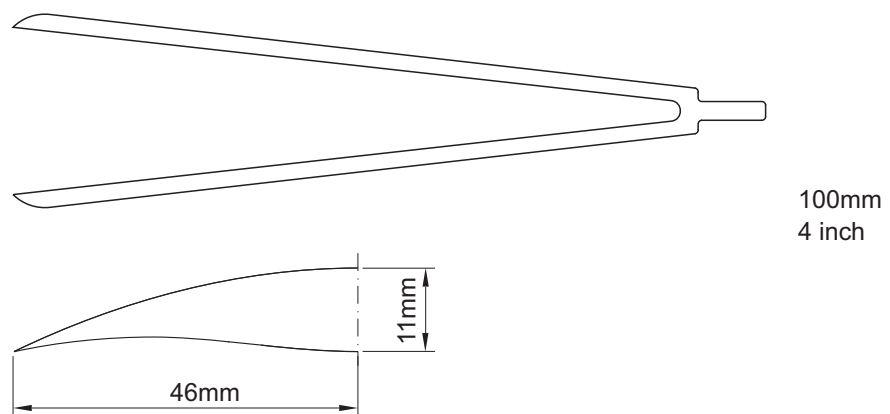

500	5328	7,38 €	Wägepinzette aus glasfaserverstärktem Delrin, sehr spitz <i>Weight Tweezer made of glass-filled Delrin, very pointed</i>
-----	------	---------------	---

Nichtmetallische Handwerkzeuge

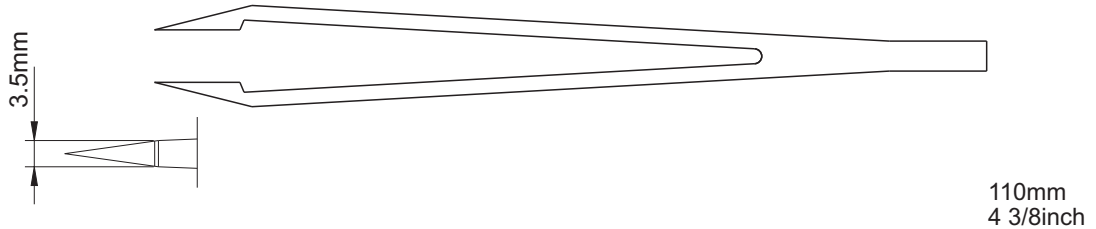

- | | | | |
|-------|------|---------------|--|
| 01 | 5310 | 6,40 € | Sehr feine Spitze, Delrin, glasfaserverstärkt
<i>Special superfine points, Delrin, glass-filled</i> |
| 01-AS | 5311 | 8,06 € | dito, jedoch aus leitfähiger CARBON-Faser
<i>Same, but made of conductive Carbon Fibre</i> |

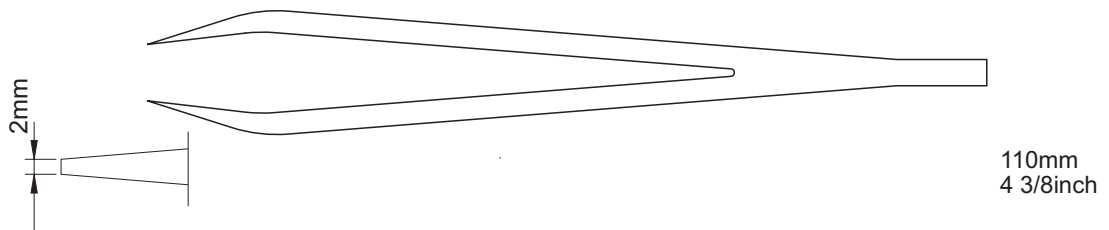

- | | | | |
|-----|------|---------------|---|
| 2aH | 5316 | 6,06 € | Flache, kräftige Spitze, 3mm breit, aus weichem Delrin, grün
<i>Flat, strong points, 3mm wide, made of softer Delrin</i> |
| 3aH | 5317 | 6,06 € | dito, jedoch aus Delrin, glasfaserverstärkt
<i>Same, but made of glass-filled Delrin</i> |

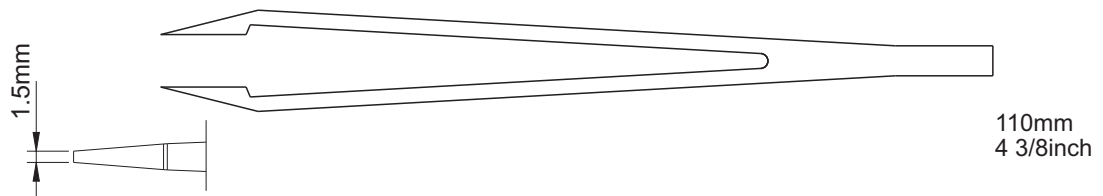

- | | | | |
|-------|------|---------------|--|
| 02 | 5334 | 6,06 € | Dünne, 1,5mm breite Spitze, Delrin, glasfaserverstärkt
<i>Flat points, 1mm wide, Delrin, glass-filled</i> |
| 02-AS | 5335 | 8,06 € | dito, jedoch aus leitfähiger CARBON-Faser
<i>Same, but made of conductive Carbon Fibre</i> |

Nichtmetallische Handwerkzeuge

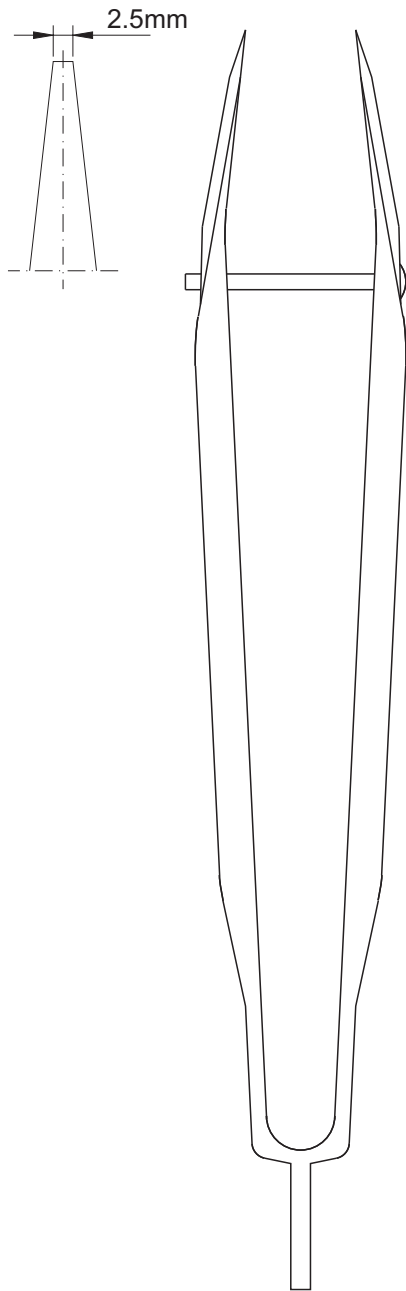

165mm
6 1/2inch

4a 5332 **20,96 €**
 2,5mm breite Spitze mit Führungsstift
 CTFE, säurebeständig, hitzebeständig bis 200°C
*2,5 wide points, with guide pin,
 CTFE, acid-resistant, heat-resistant up to 200°C*

5a 5330 **11,08 €**
 dito, jedoch aus glasfaserverstärktem
 Delrin
same, but made of glass-filled Delrin

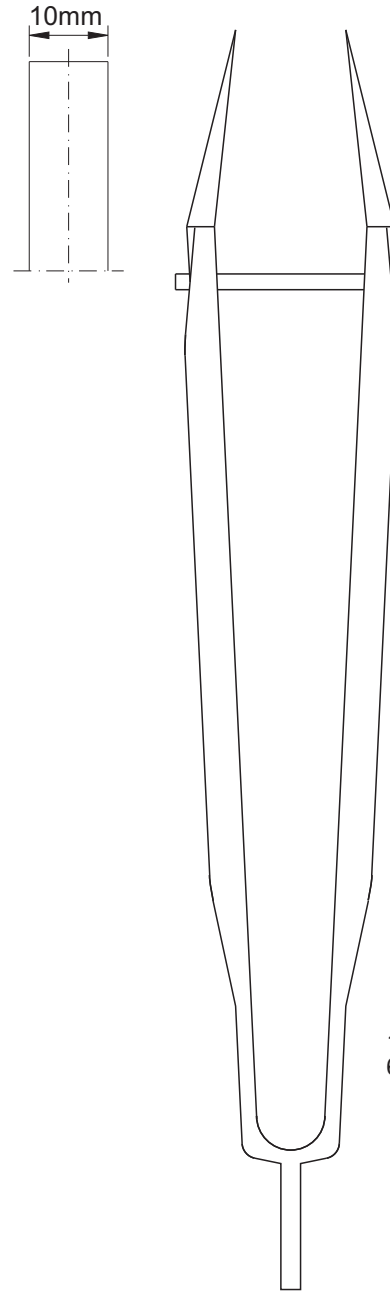

165mm
6 1/2inch

5a-1 5308 **11,38 €**
 Flache Spitze, 10mm breit, mit Führungs-
 stift, Delrin, glasfaserverstärkt
*Flat points, 10mm wide, with guide pin,
 glass-filled Delrin*

5a-2 5309 **11,72 €**
 dito, jedoch aus säurebeständigem
 Polyethylen
*same, but made acid resistand linear
 Polyethylene*

Nichtmetallische Handwerkzeuge

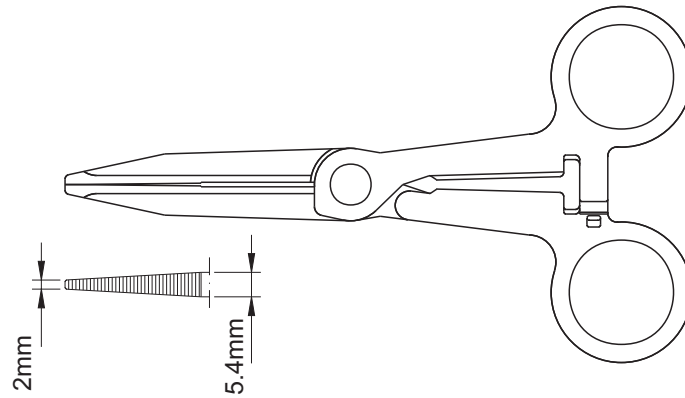

140mm
5 1/2 inch

2700 **3,16 €** Nadelhalter aus Polyethylen, glasfaserverstärkt
Needle holder made of glass-filled Polyethylene

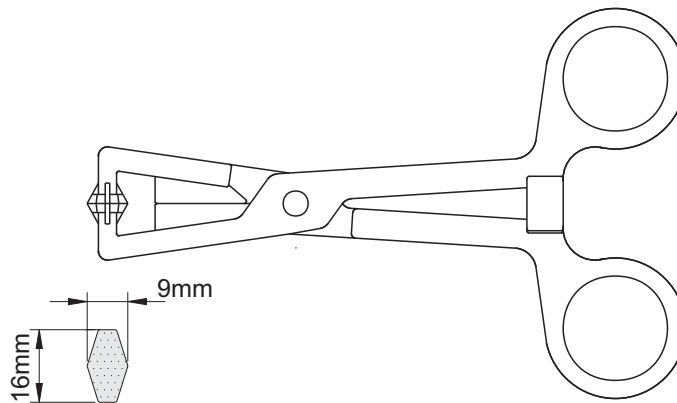

140mm
5 1/2 inch

2701 **3,38 €** Schlauchklemme aus Polyethylen
Hose Clamping Forcep made of Polyethylene

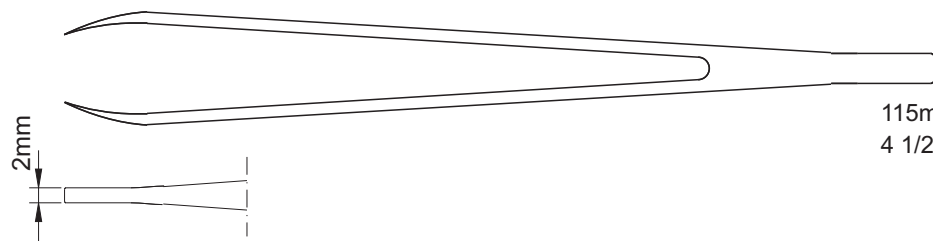

115mm
4 1/2 inch

- | | | | |
|--------|------|---------------|--|
| 300 | 5320 | 6,06 € | Nur die vorderste Spitze fasst z.B. Wafer, Delrin glasfaserverstärkt
<i>Only the points grip e.g. Wafers, glass-filled Delrin</i> |
| 300-1 | 5318 | 6,06 € | Dito, jedoch aus weicherem grünen Delrin
<i>Same, but made of softer green Delrin</i> |
| 300-AS | 5321 | 8,06 € | Dito, jedoch aus leitfähiger CARBON-Faser
<i>Same, but made of conductive Carbon Fibre</i> |

Nichtmetallische Handwerkzeuge

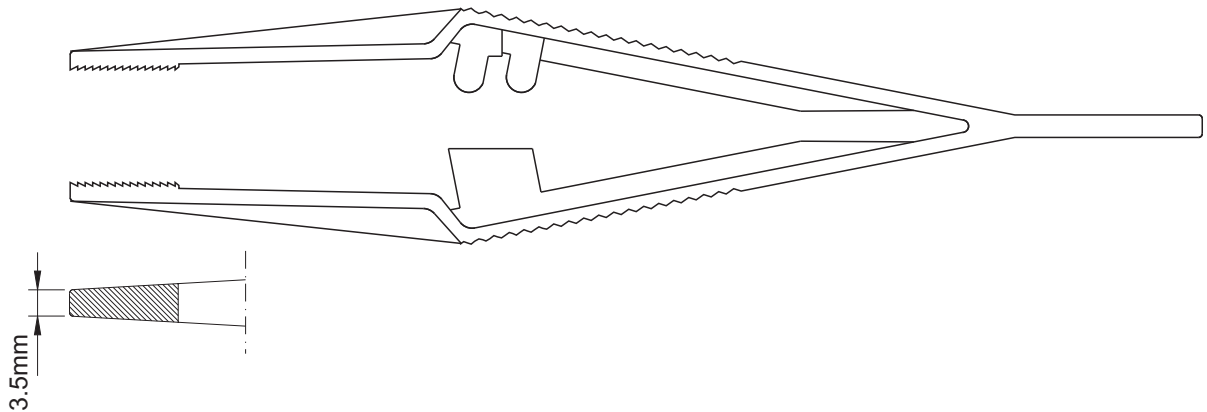

- | | | | |
|--------------|------|---------------|---|
| 707-B | 5102 | 1,22 € | Modell 707-B, Polyamid, glasfaserverstärkt, 85mm
<i>Model 707-B, polyamide, glass-filled, 3 3/8inch</i> |
| 766-B | 5100 | 2,72 € | Modell 766-B, Polyamid, glasfaserverstärkt, 150mm
<i>Model 766-B, polyamide, glass-filled, 5 7/8inch</i> |
| 767-B | 5250 | 1,66 € | Modell 767-B, Polyamid, glasfaserverstärkt, 125mm
<i>Model 767-B, polyamide, glass-filled, 5inch</i> |

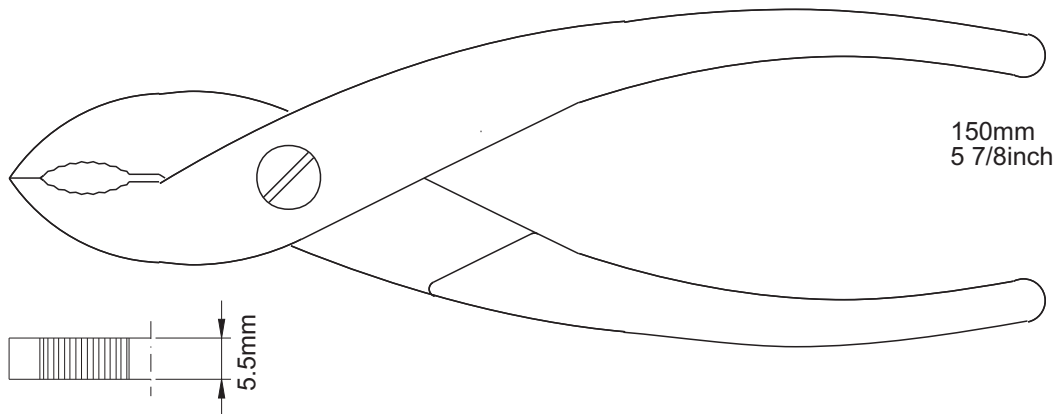

- | | | | |
|-----------|------|----------------|---|
| P1 | 2710 | 13,72 € | P1, Kombizange aus Delrin, glasfaserverstärkt
<i>P1, Combination plier made of glass-filled Delrin</i> |
|-----------|------|----------------|---|

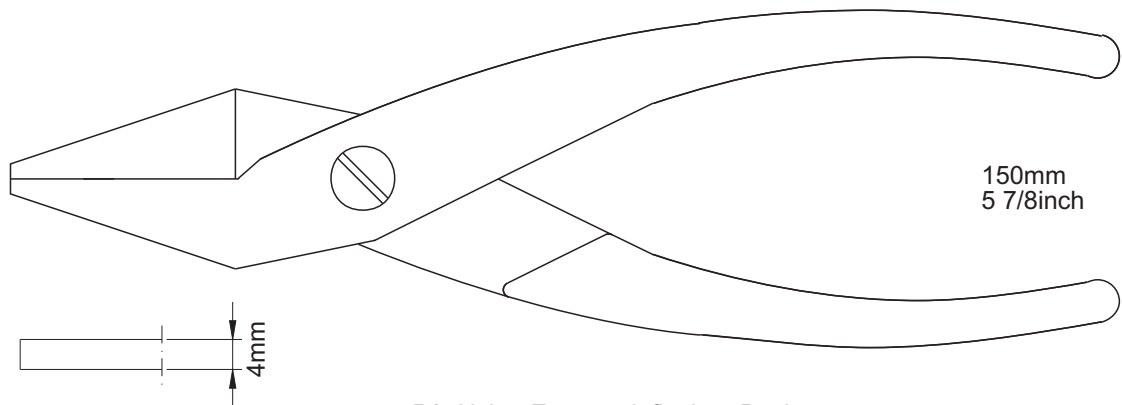

- | | | | |
|-----------|------|----------------|---|
| P2 | 2712 | 14,06 € | P2, Nylon-Zange mit flachen Backen
<i>P2, Nylon plier with flat, smooth nose</i> |
|-----------|------|----------------|---|

Nichtmetallische Handwerkzeuge

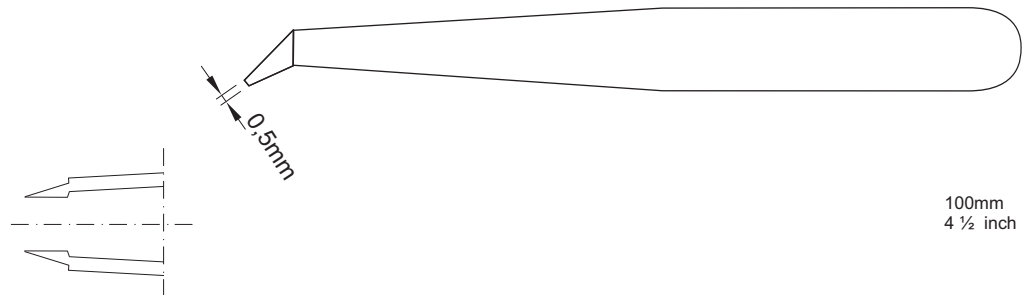

90 5333 7,38 €

Stabile, 0,5mm breite Spitze, 45° winklig gebogen,
Delrin, glasfaserverstärkt

*Strong, 0,5mm wide tips, 45° curved,
Delrin, glass-filled*

100mm
4 1/2 inch

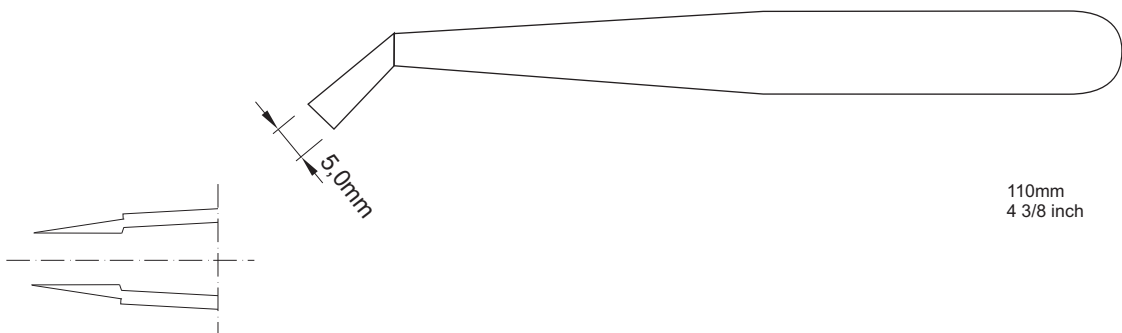

09 5331 7,38 €

Stabile, 5mm breite Spitze, 45° winklig gebogen,
Delrin, glasfaserverstärkt

*Strong, 5mm wide tips, 45° curved,
Delrin, glass-filled*

110mm
4 3/8 inch

Nichtmetallische Handwerkzeuge



14-PTFE

5214

75,52 €

Aus massivem PTFE-Stab gefertigt
 4mm breite Spitze
 Hitzebeständig bis 280 °C
 Made of solid PTFE in 1 piece
 4mm wide tips
 Heat-resistant up to 280 °C

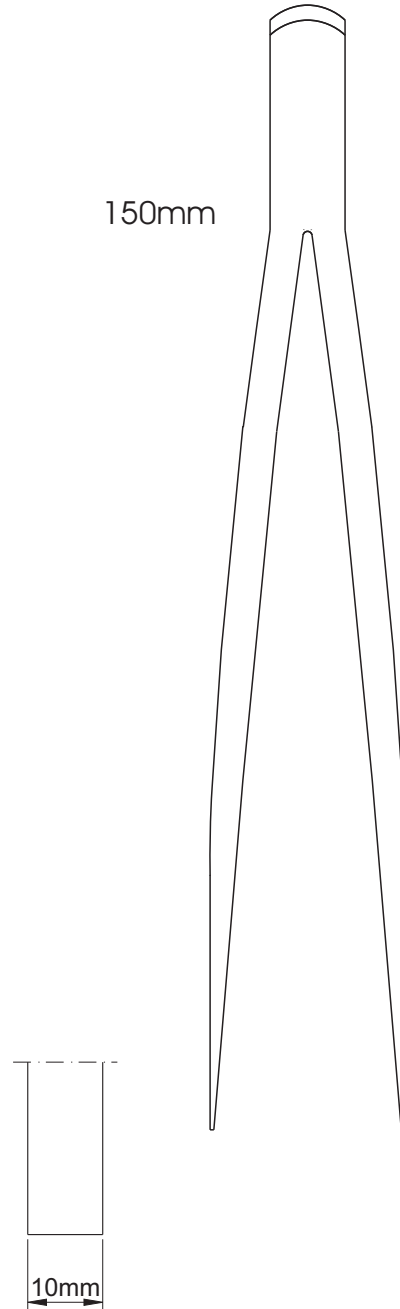

24-PTFE

5224

75,52 €

Dito, jedoch 10mm breite Spitze
 Hitzebeständig bis 280 °C
 Same, but 10mm wide tips
 Heat-resistant up to 280 °C

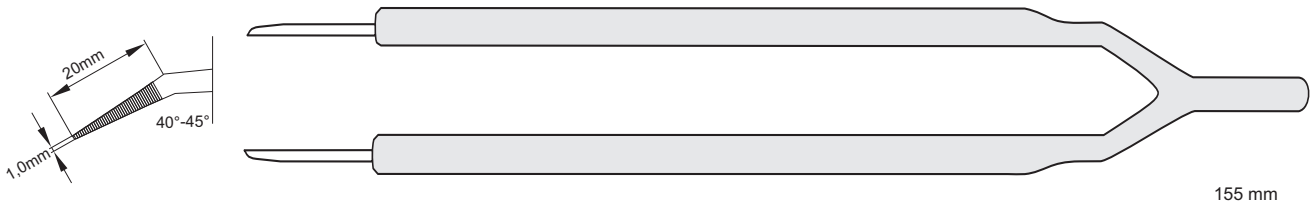

22b isol.

9157

10,12 €

Gebogen, mittelfeine Spitze, schutzisoliert
Bent, medium pointed, security-insulation

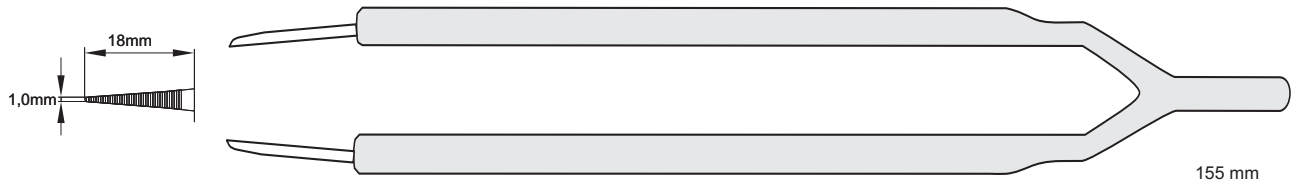

22 isol.

9158

9,60 €

Gerade, mittelfeine Spitze, schutzisoliert
Straight, medium pointed, security-insulation

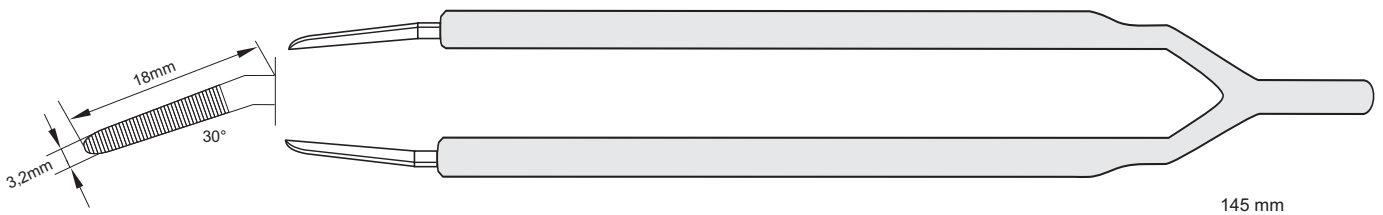

40b isol.

3016

9,48 €

Stumpf, gebogen, mittelfeine Spitze, schutzisoliert
Blunt, curved, medium pointed, security-insulation

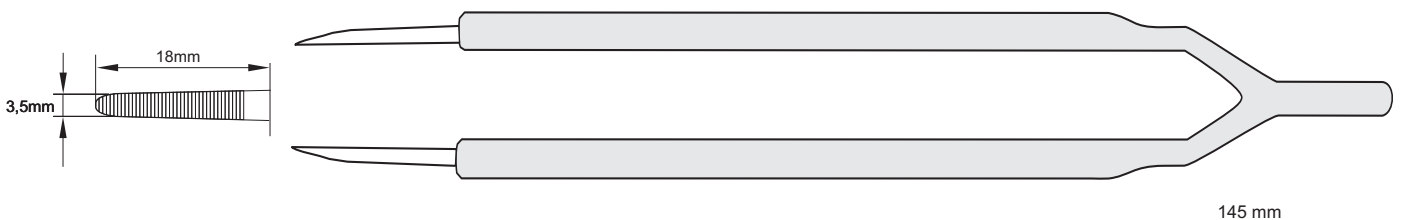

40 isol.

3015

8,80 €

Stumpf, gerade, mittelfeine Spitze, schutzisoliert
Blunt, straight, medium pointed, security-insulation

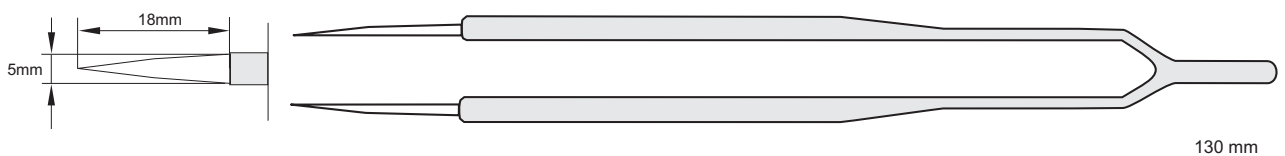

AA isol.

8100

10,46 €

Spitz, universelles Modell, schutzisoliert
Pointed, multipurpose model, security-insulation



C5

115mm

C5

8305

39,34 €

Schneidepinzette für sehr feine Drähte, Form 5

Cutting Tweezer for very fine wires, Design 5

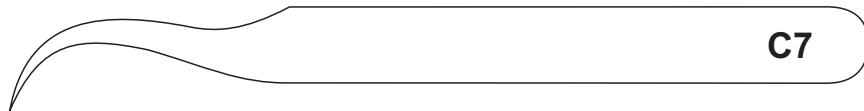

C7

120mm

C7

8307

43,04 €

Schneidepinzette für sehr feine Drähte, Form 7

Cutting Tweezer for very fine wires, Design 7

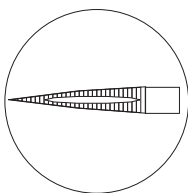

120mm

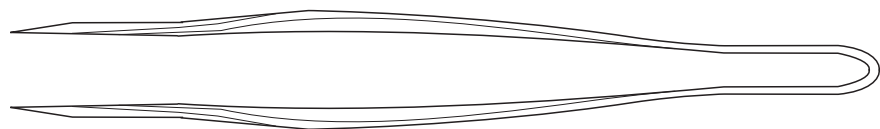

Feilchenfeldpinzette

Einteilig	7108	14,16 €	Feilchenfeldpinzette, hohle Grifffläche, mit Blutrinne in der Spitze
Einteilig	7109	17,66 €	Wie 7108, jedoch Rostfrei Same as 7108 but Stainless

Technicians helps

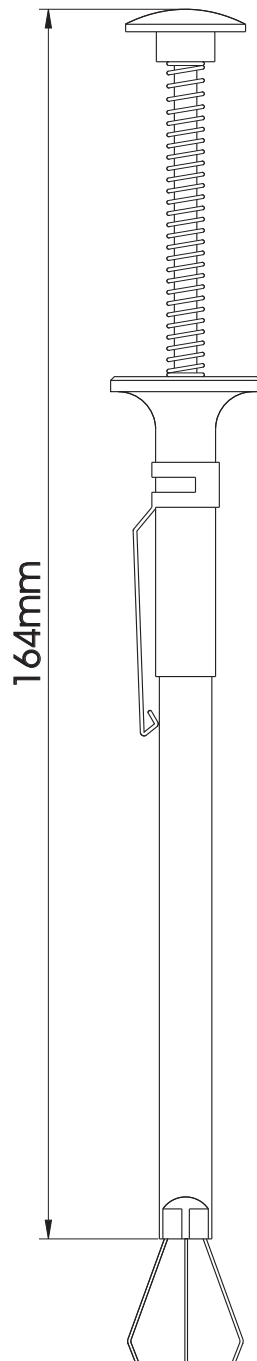

0761 **20,22 €**

Krallengreifer mit Clip, Taschenversion
Grösster \varnothing am Schaft 7,5mm
ideal zum Ablöten

*Gripper with Clip, pocket version,
max. Shank \varnothing 7,5mm
ideal for de-soldering*

Vakuum-Pinzetten

Vacuum-tweezers

Alle Vakuumpumpen mit Netzanschluss 220 Volt, andere Spannungen auf Anfrage lieferbar.
Auslieferung incl. Netzkabel, Stecker, Schalter sowie Schalldämpfer und Filter.
Gehäuse aus Aluminium, schwingungsgedämpft, mit Gummifüßen,
wahlweise mit zusätzlichem Blasanschluss.

*All vacuum pumps for 220V main power, other voltages available upon request.
Supplied with main cable, plug switch as well as silencer and filter.
Aluminium housing with rubber feet to absorb vibrations.
Additional blowing connection available as option.*

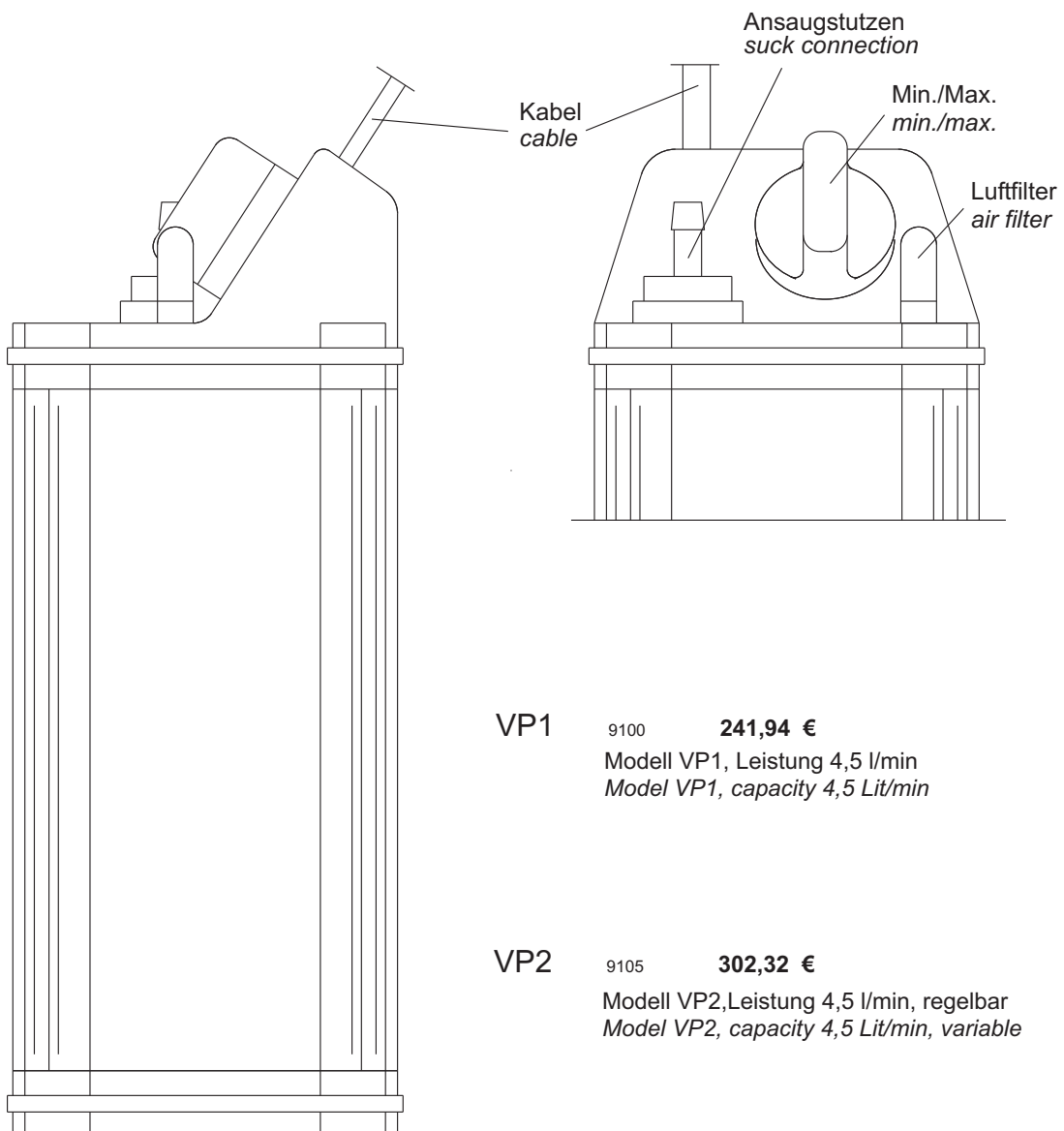

VP1 9100 **241,94 €**
Modell VP1, Leistung 4,5 l/min
Model VP1, capacity 4,5 Lit/min

VP2 9105 **302,32 €**
Modell VP2, Leistung 4,5 l/min, regelbar
Model VP2, capacity 4,5 Lit/min, variable

Vakuum-Pinzetten

Vacuum-tweezers

VP3 9110 **564,42 €**

Modell VP3, Leistung 6,5 l/min, regelbar
Model VP3, capacity 6,5 Lit/min, variable

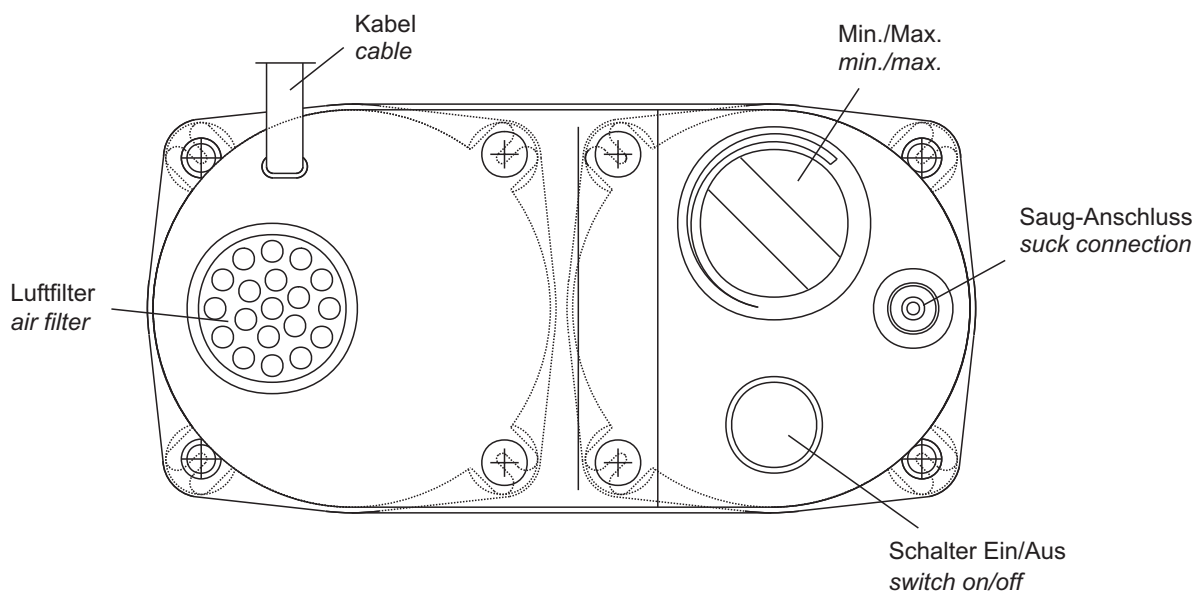
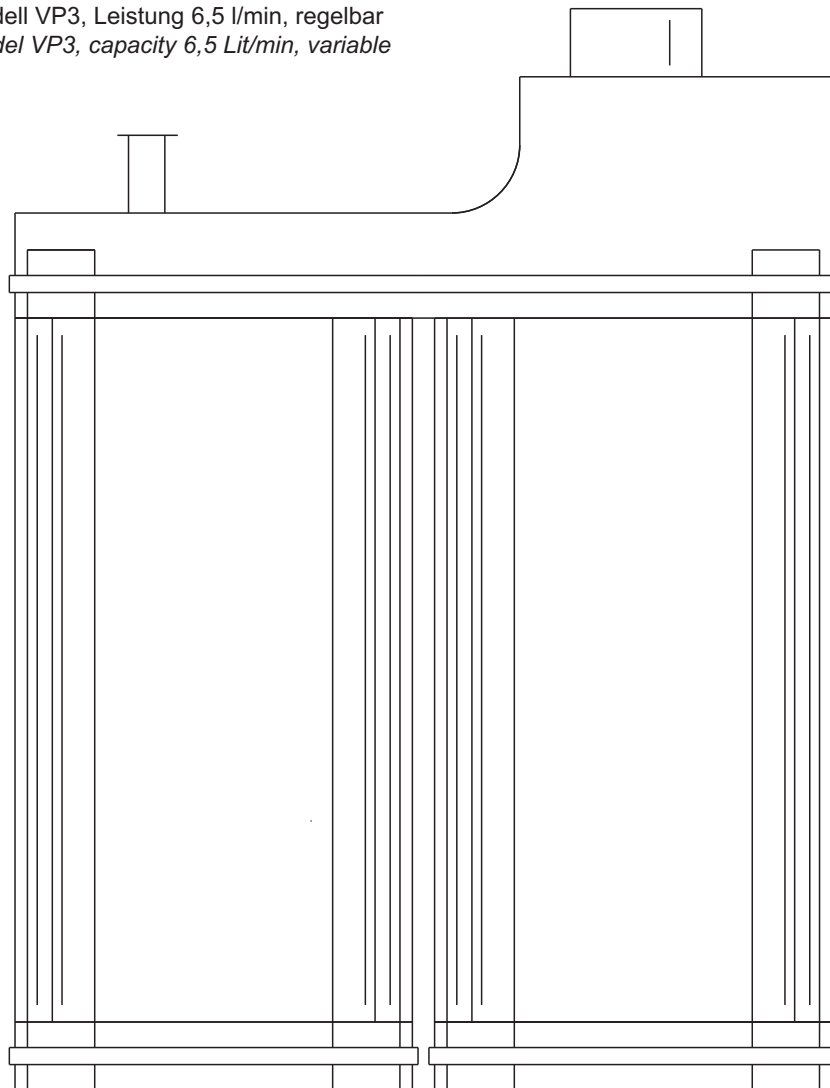

Preis/Stück: 15,76 €
Price/piece:

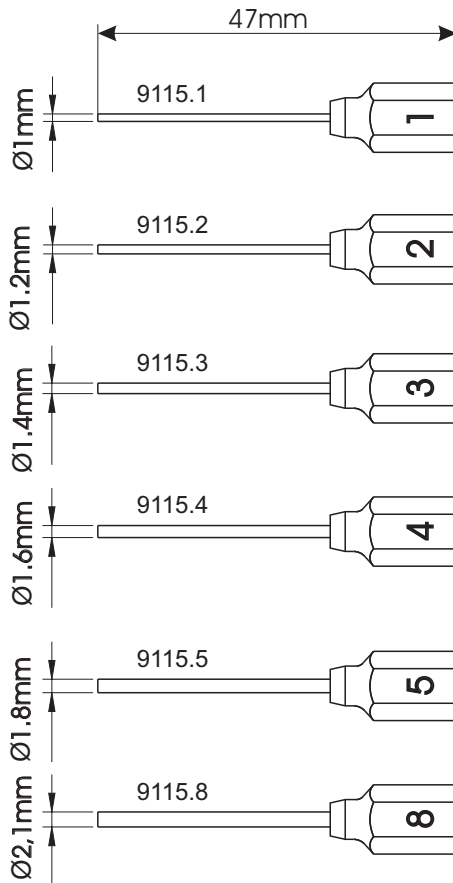

9116.1

Preis/Stück: 21,52 €
Price/piece:

9116.2

9116.3

9116.4

9116.5

9116.8

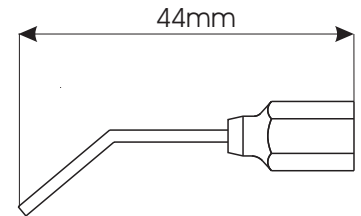

Preis/Satz:
Price/set: 9115 **91,62 €** Saugnadel-Sortiment, nichtrostend. Grössen: 1,0-1,2-1,4-1,6-1,8-2,1mm
Suction needle assortment, stainless. Sizes: 1,0-1,2-1,4-1,6-1,8-2,1mm

Preis/Satz:
Price/set: 9116 **125,20 €** Wie oben, jedoch 40° winklig gebogen
Same as 9115 but bent at 40°

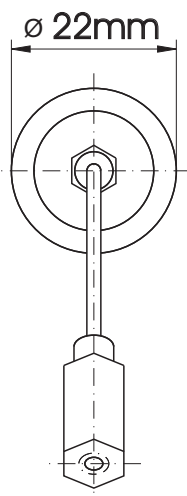

9121

101,82 €

Spezielsaugvorrichtung, speziell zum seitlichen Fassen grösserer Teile
hohe Saugkraft, 22mm

Special suction device, specifically for lateral grasping of large parts
high suction capacity, 22mm

VOMM-Vakuumpinzetten werden überall dort eingesetzt, wo die normalen Pinzetten nicht mehr schonend genug sind. Typische Anwendungsbereiche: Waferhandling, Montage kleiner optischer Systeme Handling von Solarzellen, Montage von Chips oder auch SMD-Bestückung.
Für besondere Anforderungen beschichten wir die mit den Artikeln in Berührung kommenden Teile auf Wunsch mit Teflon oder Halar (kontaminationsfrei).

*VOMM vacuum tweezers can be used wherever normal tweezers are not gentle enough.
Typical applications: wafer handling, assembly of small optical systems, handling of solar cells, chip assembly and fittings SMD's.
On request, we can coat the parts coming into contact with the articles, with Teflon or Halar (no contamination) for special applications.*

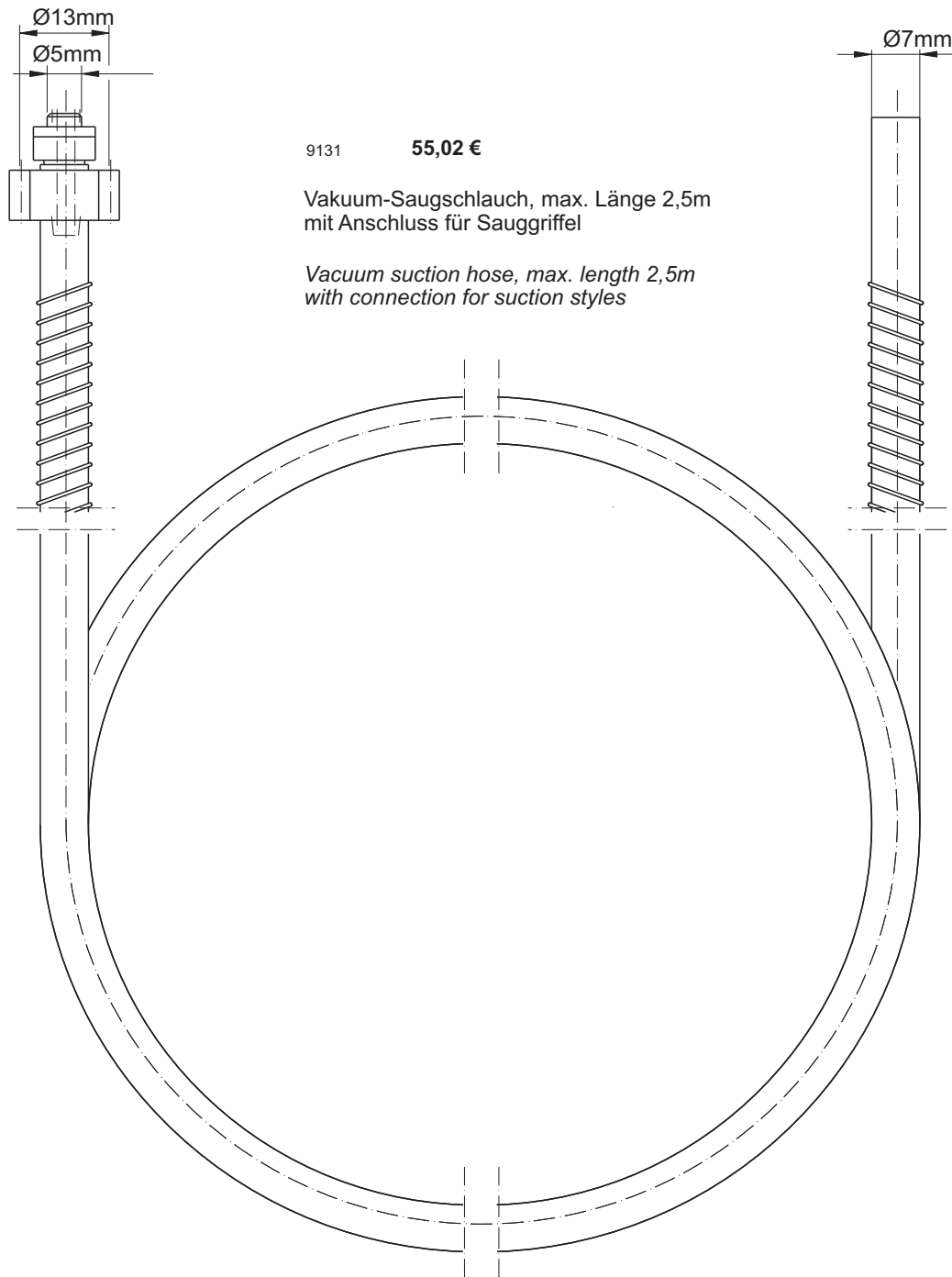

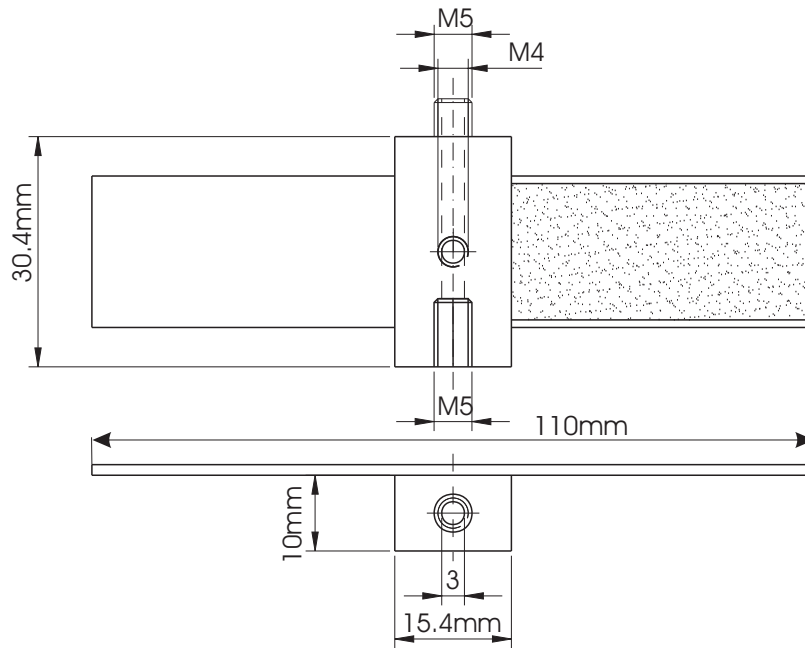

9130 **120,82 €**

Finger-Sauggriffel, mit Klettband am Finger zu befestigen und durch den Daumen zu steuern, wiegt nur 15g

Finger-mounted suction styles, secured on finger by Velcro fastener, thumb-controlled, weighs only 15g

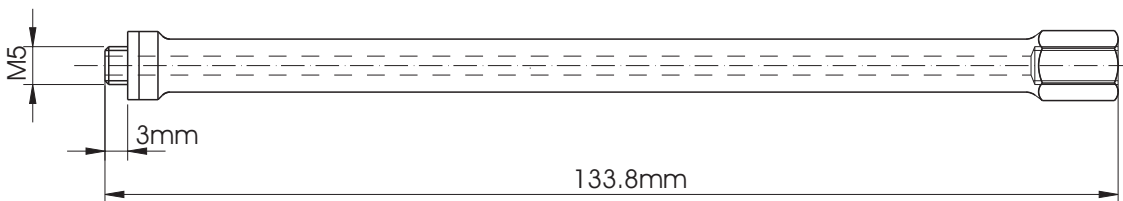

9125 **68,42 €**

Hand-Sauggriffel mit Bypass-Öffnung zum Steuern des Vakuums, wiegt nur 20g

Hand-held suction styles with bypass aperture for controlling the vacuum, weighs only 20g

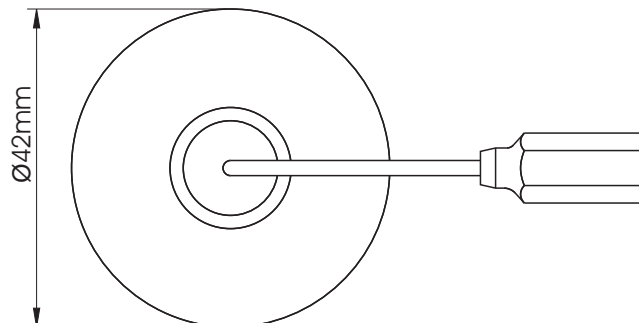

9120 **71,88 €**

Spezielsaugvorrichtung, speziell zum seitlichen Fassen grösserer Teile, hohe Saugkraft, 42mm

Special suction device, specifically for lateral grasping of large parts, high suction capacity, 42mm

Tool-Servant

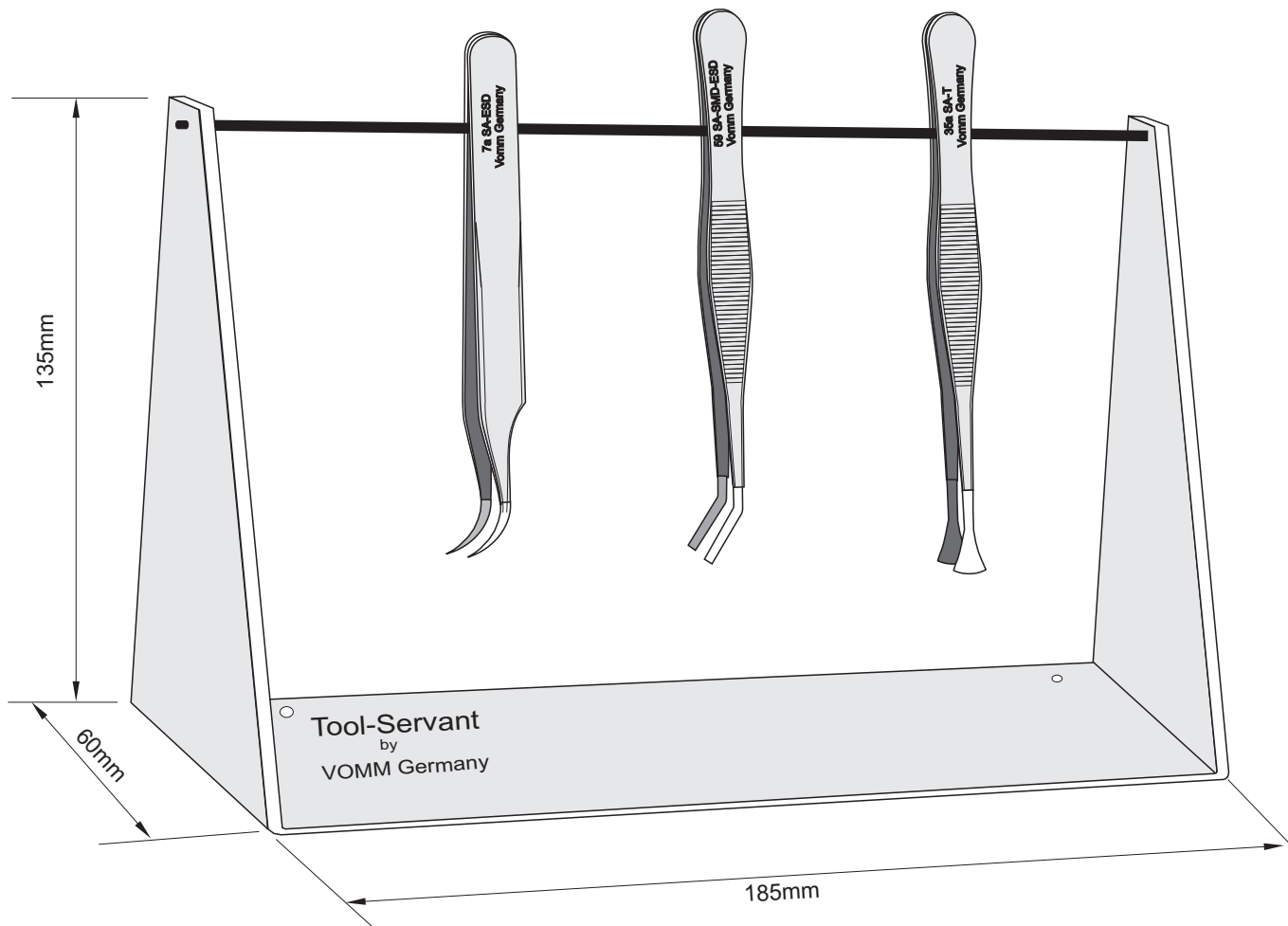

1150

24,34 €

Abmessungen: L 185mm x B 60mm x H 135mm
ESD-beschichtet, antistatisch-schwarz, säurebeständig

Measurement: L 185mm x W 60mm x H 135mm
ESD-coated, antistatic-black, anti-acid

Preis ohne Pinzetten!
Price without tweezers!





0451	10,40 €	Kunststoffgriff	Delrin	<i>Plastic handle</i>	<i>Delrin</i>	140 mm
------	----------------	-----------------	--------	-----------------------	---------------	--------



0407	4,86 €	Griff, Messing, vernickelt / verchromt		<i>Brass, nickel-plated / chromated handle</i>		125 mm
0408	9,84 €	Griff, Rostfrei		<i>Stainless Steel handle</i>		

0467	38,66 €	Teleskopgriff, vernickelt verchromt		<i>Telescope-handle, nickel-plated / chromated</i>		
------	----------------	-------------------------------------	--	--	--	--



145 mm - 640 mm

Mundspiegel

zum Einbauen in obige Griffe

Mouth-mirrors to be implemented in above

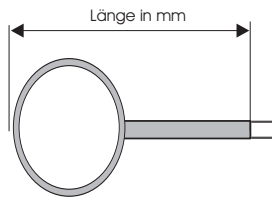

0510	9,98 €	∅	10 mm	35 mm
0514	9,98 €	∅	14 mm	35 mm
0516	4,36 €	∅	16 mm	35 mm
0518	4,50 €	∅	18 mm	38 mm
0520	4,68 €	∅	20 mm	38 mm
0522	4,78 €	∅	22 mm	39 mm
0524	5,06 €	∅	24 mm	39 mm
0526	5,68 €	∅	26 mm	43 mm
0528	5,98 €	∅	28 mm	43 mm
0530	6,36 €	∅	30 mm	44 mm
0560	21,34 €	∅	60 mm	71 mm

VOMM[®]
GmbH

